

Operation Manual

software release **3.0**

TP0716-01

FIRST PRINTING: **MARCH 1997**

MODEL 1200
DIGITAL PRODUCTION SWITCHER

Customer Service Information

Address

Mail:
P.O. Box 1114
Grass Valley, CA 95945

Shipping Only:
400 Providence Mine Rd
Nevada City, CA 95959

Telephone

Tektronix, North America: (800) 547-8949

Tektronix, UK: 44-1628-403699

Tektronix, Hong Kong: 852-2593-5500

Tektronix, Brazil: 55 11 3741-8417

Tektronix, Mexico: 52 5 666-6333

Elsewhere: Distributor or sales office from whom equipment was purchased

Fax: (916) 478-3181

Note that as of November 1, 1997 the FAX number changes to (530) 478-3181

E-Mail: gvgservice@tek.com

Tektronix World Wide Web

<http://www.tek.com>

Copyright © Tektronix, Inc. All rights reserved. Printed in U.S.A.

Tektronix products are covered by U.S. and foreign patents, issued and pending. Information in this publication supersedes that in all previously published material. Specifications and price change privileges reserved. TEKTRONIX, TEK, Grass Valley Group, Borderline, E-MEM, TEN-X, Wavelink, and  are registered trademarks, and Air Link, Auto Match, Doubletake, E-Disk, Eagle V, Emphasys, EZ-Link, 409, Horizon, Grass Valley, Jogger, Kadenza, Kaleidoscope, K-Mask, Key-Layer, Key-Link, Krystal, MASTER System, Master 21, MAX, Omni-Key, Performer, Programmed Motion, Silhouette, Softset, Streamline, Super Edit, TEN-20, 20-TEN, Trace, TrailBlazer, VideoDesktop, Flex-Time, and XEDL are trademarks of Tektronix, Inc. P.O. Box 1000 Wilsonville, OR 97070-1000 U.S.A.

The information in this manual is furnished for informational use only, is subject to change without notice, and should not be construed as a commitment by Tektronix, Inc. Tektronix assumes no responsibility or liability for any errors or inaccuracies that may appear in this publication.

Tektronix, Inc., Video and Networking Division, P.O. Box 1114 Grass Valley, California 95945 U.S.A.



Contents

Section 1 — Introduction

Introduction	1-1
Section Contents	1-1
Features of the Model 1200	1-2
Model 1200 Overview	1-4

Section 2 — Startup

Introduction	2-1
System Startup or Restart	2-2
Startup	2-2
Restart	2-2
LampSaver Panel Sleep Mode	2-2
Concepts You'll Need to Know	2-3
Delegation	2-3
Crosspoint Bus	2-3
Transition	2-4
Cut Transition	2-4
Mix Transition	2-4
Wipe Transition	2-5
Key	2-6
Luminance Key	2-6
Linear Key	2-7
Preset Pattern Key	2-8
Chroma Key	2-8
Shaped Video	2-10
Effects Send	2-10
Z-Key™ Depth	2-11
E-MEM® Effects Memory	2-11

System Setup: Using the Configuration Menus	2-12
Menu Pushbuttons and Knobs	2-12
Configuration Menu	2-13
System Parameters Menu	2-14
Define Inputs Menu	2-16
Define Inputs	2-16
Chroma Key Sources Menu	2-18
Crosspoint Display Legends Menu	2-19
Crosspoint Map Menu	2-20
Outputs Menu	2-22
Timing Menu	2-23
Port Menu	2-24
GPI Menus	2-26
Tally Menu	2-28

Section 3 — Controls & Menus

Introduction	3-1
Bus Delegates	3-4
Crosspoint Buses	3-5
PST (Preset) Bus	3-6
PGM (Program) Bus	3-6
Key Bus	3-7
Aux Bus 1 and Aux Bus 2	3-8
Satellite Aux Bus Panels	3-8
Downstream Keyer (DSK)	3-9
DSK Preview	3-10
DSK Cut	3-10
DSK Mix	3-10
Effects Send	3-11
E-MEM Effects Memory	3-12
Learn Button	3-12
Register Buttons	3-13
Undo/Decimal Point	3-13
Trans Buttons	3-14
Clear	3-14

External Interface	3-15
Editor Enable	3-15
GPI Enable	3-15
DPM Enable	3-15
Fade To Black	3-16
Black Cut	3-16
Black Mix	3-16
Keyer	3-17
Keyer Delegation Pushbuttons	3-17
Key Source Type: Video Key and Auto Select Key	3-18
Split Key	3-18
Key Fill: Video or Matte	3-19
Key Type: Linear Key, Luma Key, Chroma Key, Preset Pattern	3-19
Linear Key	3-19
Luma Key	3-20
Chroma Key and Auto Setup	3-20
Preset Pattern	3-21
Key Modifiers and Adjustments	3-21
Key Over	3-21
Invert	3-21
Mask	3-22
Force Mask	3-22
Show Key	3-22
Key Opacity	3-22
Gain and Clip	3-23
Borderline	3-24
Normal	3-24
Border	3-24
Shadow	3-24
Extrude	3-24
Outline	3-25
Key Memory and Key Copy Features	3-25
Matte	3-26
Matte Controls	3-26
Matte Delegation	3-26

Pattern	3-28
Pattern Selection Buttons	3-29
User Wipe Buttons	3-29
Pattern Adjustments	3-30
Positioner (Joystick)	3-30
Wipe Direction	3-30
Mask Preset Pattern/Wipe	3-30
Size and Border Width, Softness, and Symmetry	3-31
Mask/Preset Invert	3-31
Wipe Menu	3-31
Transition	3-32
Bkgd, Key 1, Key 2	3-33
Bkgd	3-33
Key 1 and Key 2	3-33
Mix and Wipe Transition Type	3-34
Mix	3-34
Wipe	3-34
Transition Controls: Cut, Auto Trans, and Lever Arm	3-35
Visual Display and Menus	3-36
Menu Pushbuttons and Knobs	3-37
Keypad Numeric Entry	3-37
Double-Press Pushbuttons	3-38
Menus	3-39
Menu Tree	3-40
Chroma Key Menus	3-42
Chroma Key Menu Functions:	3-42
Chroma Key Auto Setup Menu	3-44
Auto Setup Menu Functions:	3-44
Chroma Key Fgd Suppress Menu	3-46
Foreground Suppress Menu Functions:	3-46
Chroma Key Edge Menu	3-48
Chroma Key Edge Menu Functions:	3-48
Chroma Key Shadow Proc Menu	3-50
Shadow Proc Menu Functions:	3-50
Chroma Key Force Mask Menu	3-52
Force Mask Menu Functions:	3-52

- Configuration Menus 3-54
 - Configuration Menu Functions: 3-54
 - System Parameters Menu 3-56
 - System Parameters Menu Functions: 3-56
 - Define Inputs Menu 3-58
 - Define Inputs Menu Functions: 3-58
 - Configuration Name Inputs Menus 3-60
 - 4:4:4 Chroma Key Sources Menu 3-62
 - Crosspoint Display Legends Menu 3-64
 - Crosspoint Display Legends Menu Functions: 3-64
 - Crosspoint Map Menu 3-66
 - Crosspoint Map Menu Functions: 3-66
 - Outputs Menu 3-68
 - Outputs Menu Functions: 3-68
 - Timing Menu 3-70
 - Port Configuration Menu 3-72
 - Port Configuration Menu Functions: 3-72
 - GPI Menus 3-74
 - GPI Input and Output Menu Functions: 3-74
 - Tally Menu 3-76
 - Tally Menu Functions: 3-76
- Copy/Swap Menus 3-77
- Disk Menus 3-82
 - Disk Menu Functions: 3-82
 - Disk Save Menu 3-84
 - Disk Save Menu Functions: 3-84
 - Save Switcher Configuration to Disk 3-86
 - Name File 3-88
 - Disk Load Menu 3-90
 - Disk Load Menu Functions: 3-90
 - Load Configuration and Load All 3-91
 - Disk Util Menu 3-92
 - Disk Load Menu Functions: 3-92
 - Moving Files to Other Directories 3-93
 - Name Directory 3-94
 - Disk Format Menu 3-96
 - Disk Format Menu Functions: 3-96
 - Name Volume 3-98

Keyer Menu	3-100
Keyer Menu Functions:	3-100
Key Border	3-102
Last Menu	3-104
Misc Menu	3-104
Priority/Depth Menu	3-106
Priority/Depth Menu Functions:	3-106
Proc Amp Menus	3-108
Proc Amp Menu Functions:	3-108
Status Menus	3-110
Wipe Menu	3-112
Wipe Menu Functions:	3-112
Wipe Multiply Menu	3-114
Wipe Multiply Menu Functions:	3-114
Wipe Modulation Menu	3-116
Wipe Modulation Menu Functions:	3-116
Readout Display Option	3-118

Section 4 — Basic Operations

Introduction	4-1
Starting Conditions	4-1
Transitions	4-2
Background Cut	4-2
Background Mix	4-3
Background Wipe	4-4
Learning User Wipes	4-5
Fade to Black	4-6
Setting Transition Rates	4-6
Matte Effects	4-7
Luminance and Linear Keying	4-8
Key Transition	4-10
Preset Pattern Keying	4-12
Chroma Keying	4-14
Using E-MEM Effects Memory	4-16

Section 5 — Advanced Operations

- Introduction 5-1
- Starting Conditions 5-1
- Proc Amp Controls 5-2
 - Monochrome Video Effect 5-3
- Matte Wash 5-4
 - Matte Wash Method 1 5-4
 - Matte Wash Method 2 5-5
- Spotlight 5-6
 - Spotlight Method 1 5-6
 - Spotlight Method 2 5-7
- Advanced Chroma Keying 5-8
- Using Effects Send to Fly a Key 5-10
- Using Aux Buses to Fly a Key 5-11

List of Illustrations

Figure 1-1	Model 1200 Simplified Functional Block Diagram	1-4
Figure 2-1	A Mix Transition	2-4
Figure 2-2	A Wipe Transition	2-5
Figure 2-3	Luminance Key Example	2-7
Figure 2-4	Chroma Key Example	2-9
Figure 2-5	1200 Configuration Menu Tree	2-12
Figure 2-6	Configuration Menu	2-13
Figure 2-7	System Parameters Menu	2-15
Figure 2-8	Define Inputs Menu	2-17
Figure 2-9	4:4:4 Chroma Key Sources Menu	2-18
Figure 2-10	Crosspoint Display Legends Menu	2-19
Figure 2-11	Crosspoint Map Menu	2-21
Figure 2-12	Outputs Menu	2-22
Figure 2-13	Timing Menu	2-23
Figure 2-14	Port Configuration Menu	2-25
Figure 2-15	GPI Inputs Menu	2-27
Figure 2-16	GPI Outputs Menu	2-27
Figure 2-17	Tally Menu	2-28
Figure 3-1	Model 1200 Control Panel	3-2
Figure 3-2	Bus Delegates Panel	3-4
Figure 3-3	Crosspoint Buses	3-6
Figure 3-4	Downstream Keyer (DSK) Panel Section	3-9
Figure 3-5	Effects Send Panel Section	3-11
Figure 3-6	E-MEM Panel Section	3-12
Figure 3-7	External Interface Panel Section	3-15
Figure 3-8	Fade To Black Panel	3-16
Figure 3-9	Keyer Panel	3-17
Figure 3-10	Foreground Clip/Background Clip Operation	3-23
Figure 3-11	Borderline Modes	3-25
Figure 3-12	Matte Panel Section	3-27
Figure 3-13	Pattern Panel Section	3-28
Figure 3-14	Transition Controls	3-32
Figure 3-15	Visual Display Panel Section	3-36
Figure 3-16	Display Menu Tree	3-40
Figure 3-17	Chroma Key Top Menu	3-43
Figure 3-18	Chroma Key Auto Setup Menu	3-45

List of Illustrations – continued

Figure 3-19	Chroma Key Foreground Suppress Menu	3-47
Figure 3-20	Chroma Key Edge Menu	3-49
Figure 3-21	Chroma Key Shadow Proc Menu	3-51
Figure 3-22	Chroma Key Force Mask Menu	3-53
Figure 3-23	Configuration Top Menu	3-55
Figure 3-24	System Parameters Menu	3-57
Figure 3-25	Define Inputs Menu	3-59
Figure 3-26	Signal Name Menu	3-61
Figure 3-27	Local Name Menu	3-61
Figure 3-28	4:4:4 Chroma Key Sources Menu	3-63
Figure 3-29	Crosspoint Display Legends Menu	3-65
Figure 3-30	Crosspoint Map Menu	3-67
Figure 3-31	Outputs Menu	3-69
Figure 3-32	Timing Menu	3-71
Figure 3-33	Port Configuration Menu	3-73
Figure 3-34	GPI Inputs Menu	3-75
Figure 3-35	GPI Outputs Menu	3-75
Figure 3-36	Tally Menu	3-77
Figure 3-37	Copy/Swap Proc Amp Menu	3-78
Figure 3-38	Copy/Swap Keyer Menu	3-79
Figure 3-39	Copy/Swap Matte Menu	3-80
Figure 3-40	Copy/Swap Border Menu	3-81
Figure 3-41	Disk Top Menu	3-83
Figure 3-42	Disk Save Menu	3-85
Figure 3-43	SAVE CONFIG in Disk Save Menu	3-87
Figure 3-44	File Name Menu	3-89
Figure 3-45	Disk Load Menu	3-91
Figure 3-46	Disk Util Menu	3-93
Figure 3-47	Directory Name Menu	3-95
Figure 3-48	Disk Format Menu	3-97
Figure 3-49	Volume Label Menu	3-99
Figure 3-50	Keyer Menu	3-101
Figure 3-51	Key Border Menu	3-103
Figure 3-52	Miscellaneous Menu	3-105
Figure 3-53	Priority/Depth Menu	3-107
Figure 3-54	Proc Amp Menu	3-109
Figure 3-55	Status Menu	3-111
Figure 3-56	Wipe Top Menu	3-113

List of Illustrations – continued

Figure 3-57	Wipe Multiply Menu	3-115
Figure 3-58	Wipe Modulation Menu	3-117
Figure 4-1	Background Cut	4-2
Figure 4-2	Background Mix Transition	4-3
Figure 4-3	Background Wipe Transition	4-5
Figure 4-4	Luminance/Linear Key	4-9
Figure 4-5	Preset Pattern	4-13
Figure 4-6	Chroma Key	4-14
Figure 5-1	Spotlight Effect	5-7
Figure 5-2	Flying a Chroma Key Using Effects Send	5-10

1

Introduction

Introduction

Welcome to the Model 1200 Operation manual. This manual will help you get the most out of the power built into the compact Model 1200. You can either use the manual as a tutorial to help you learn the switcher, beginning with this section and working your way to the end, or you can use the book as a reference tool to answer occasional questions.

Also, don't overlook the Quick Reference Guide tucked into the pocket inside the front cover of this book. The Quick Reference Guide presents operating procedures in the shortest possible form. If you are an experienced operator who wants only a quick overview of operating procedures and an occasional reminder, the Quick Reference Guide may be all you will need.

Section Contents

This section of the Operation manual discusses the following topics:

- Features of the Model 1200—page 1-2
- Model 1200 Overview—page 1-4

Features of the Model 1200

The Model 1200 Digital Production Switcher is a moderately-priced yet powerful one mix/effects component digital mixer. It offers the tremendous advantage of digital video as well as many desirable mixing and special effects features:

- Ten-bit component digital format for excellent signal quality and virtually unlimited effects layering. Aspect ratio can be set for 4:3 or 16:9 (13.5 MHz).
- Up to 16 digital video or key inputs plus internal black and background. Optional inputs may be parallel, serial, or some of each. Inputs may be auto-timed, mapped to crosspoints, and level-adjusted by built-in processing amplifiers.
- Ten Crosspoint Switching Buses: Program Background, Preset Background, Key 1 Source and Fill, Key 2 Source and Fill, DSK Source and Fill, Auxiliary 1, and Auxiliary 2.
- One effects keyer and one downstream keyer plus an optional second effects keyer. Each keyer creates luminance, linear, preset pattern, and chroma keys (optional) from inputs selected on the Key Bus. Keys can be inverted and masked.
- Optional Chroma Keyer accepts 4:2:2 or 4:4:4 inputs. Includes adjustable background and foreground suppression and choice of additive or multiplicative key.
- Effects transition controls include cut, lever arm, and frame-accurate automatic transition. Effect modes include Mix, Wipe, and Cut. Effects backgrounds and keys can be transitioned on or off separately or simultaneously.
- Separate DSK controls include cut, frame-accurate automatic mix, and frame-accurate fade to black.
- Effects key layers can be adjusted for opacity and priority of one key over another.
- Z-Key™ Depth option accepts depth keys from Grass Valley digital effects systems for compositing intersecting plane effects with adjustable offset. Non-depth keys can be offset so that new layers can be recorded between existing layers.

- Depth option includes Layered mode that composites both M/E keys onto the switcher Key output.
- Effects Send enables flying switcher effects keys over switcher backgrounds using an external Grass Valley digital effects system. (Requires Effects Send/Aux Output option.)
- Borderline® Key Edger option available for each keyer includes borders, drop shadows, outlines, and extrusions.
- Wipe/mask system includes twenty patterns with H and V multiples and matte edge adjustable for width, softness, and softness symmetry. Patterns can also be adjusted for position, aspect, rotation, and modulation. New approach to pattern generation provides smoother wipe transitions.
- Many internal mattes available, including background matte, matte fill for each keyer, separate matte for each Borderline mode, wipe edge matte, preset pattern edge matte, and mattes generated by any number of crosspoints if enabled via menus.
- Twenty panel-operated E-MEM® registers provide storage and recall of effects and auto transitions.
- Contact-closure GPI interface includes 8 inputs for external triggering of switcher functions and 8 outputs for switcher triggering of other devices. Outputs can be synchronized with switcher transitions.
- Sixteen tally relay outputs.
- Four serial ports for serial interface to an editor, a DPM, and other external devices.
- Optional preview system for previewing effects.
- Optional parallel digital or serial digital outputs.
- Optional component analog monitor outputs.
- Built-in panel display includes menus, soft knobs for additional control of many switcher functions, and a floppy disk drive for storing system configuration and E-MEM files.
- LampSaver mode turns off panel lamps to reduce lamp burnout during idle periods.

Model 1200 Overview

The Model 1200 architecture (Figure 1-1) consists of a single mix/effects system with two keyers and a downstream keyer. Video inputs selected on the background crosspoint buses enter a pair of program and preview mixers. Video and key inputs selected on the key crosspoint bus are first processed in the keyer circuits. If effects send mode is off, the keyer outputs go directly to the mixers, and any aux bus selections go directly to the aux outputs. If effects send mode is on, the key and fill outputs of one of the keyers are routed via the aux bus outputs to a DPM, and the

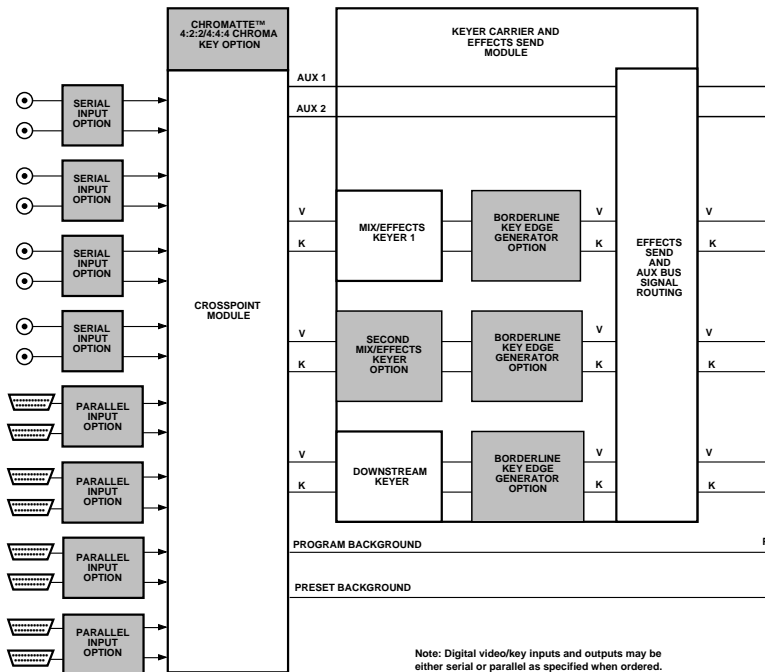
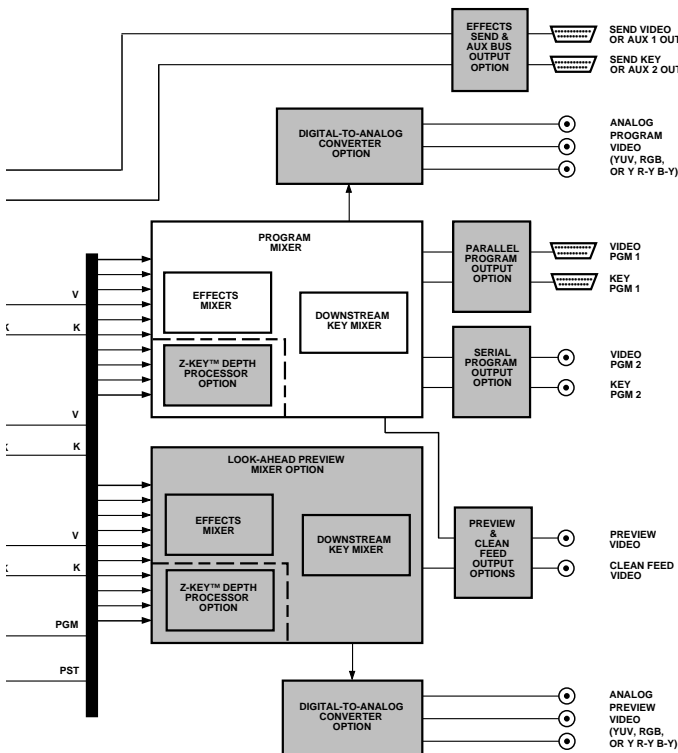

Figure 1-1. Model 1200 Simplified Functional Block Diagram

aux buses automatically select the manipulated key and fill inputs returning from the DPM. The aux buses then apply the manipulated key and fill signals to the mixers. The mixers multiply the processed background and key signals to produce mixed effects video. The effects video enters the downstream key mixers where the DSK signal is mixed over the effects layer. The final output signals then pass through output processing to the various analog, serial digital, and parallel digital outputs



2

Startup

Introduction

This section of the manual helps you get started using the switcher. The following topics are discussed:

- System Startup or Restart—page 2-2
- Concepts You'll Need to Know—page 2-3
- System Setup: Using the Configuration Menus—page 2-12

You might be tempted to skip over the “Concepts” part of this section, especially if you are an experienced switcher operator. Nevertheless, we advise you to read it anyway because it explains operating concepts specific to the 1200 switcher that will help you to more fully understand how the 1200 works.

System Startup or Restart

Startup

1. Set the 0/1 power switch inside the front cover of the switcher frame to the 1 (on) position.
2. Set the 0/1 power switch inside the switcher control panel to the 1 (on) position.

This applies power to the entire system, which will boot up and become operational in a few seconds. To power down the system at any time, just switch both power switches to 0 (off).

Restart

If the system becomes confused or locks up, you can restart it as explained below. The effect you were working on will be lost, but E-MEM contents and configuration files will remain intact.

1. Press the **[Misc]** menu button in the upper left corner of the control panel. Then press the **[CLR WORK BUFFER]** soft button in the Miscellaneous Menu to clear the panel.
2. If clearing the panel didn't help, press the **RESET** switch on the Control module (064911) inside the switcher frame.
3. Finally, if neither of the above steps resolves the problem, turn the frame and panel power switches off and on again.

LampSaver Panel Sleep Mode

Note that the switcher includes a “sleep” mode called LampSaver, which is intended to extend pushbutton lamp life-span. When the switcher is idle for an extended period (adjustable) all button lamps turn off. To wake up the switcher, press any button or turn any knob. For details about the LampSaver mode, see the description of the Miscellaneous menu in Section 3.

Concepts You'll Need to Know

There are a few basic concepts that you should know before you begin setting up and operating the switcher. These concepts are presented on the following pages.

Delegation

Some switcher functions, when selected, automatically activate related subpanels or functions. This is called *delegation*. For example, when you press the **[Key 1]** button in the Transition subpanel, the Keyer subpanel delegates to control Keyer 1. Related functions delegate in logical ways, making operation easier because fewer button pushes are required.

Sometimes, even with the help of automatic delegation, you must still delegate a function manually. If a subpanel or function doesn't respond when you operate it, check that it is delegated to the function you are trying to control.

Crosspoint Bus

A *crosspoint bus* consists of a group of switches called *crosspoints*, each with a different video or key input and a common output called a *bus*. The switches allow you to select an input for connecting to the output. The outputs of the various buses feed the switcher's effects and transition circuits.

There are a number of buses in the Model 1200, including the PGM (Program) and PST (Preset) background buses, the Key buses, and the Aux (auxiliary) buses. The background buses feed the video mixers, allowing you to select background sources and do transitions between them. The key buses feed the keyers, allowing you to set up keys, which are also fed to the mixers for keying over the background. Lastly, the aux buses select signals and send them directly to a switcher output for feeding external devices, such as digital picture manipulators; this makes the same inputs that are available to the switcher also available to the external devices.

Transition

A *transition* is a change from one video picture or to another. The Model 1200 provides three methods for making video transitions: a cut, a mix, and a wipe.

Cut Transition

A *cut* is an instantaneous switch from one picture to another. A background cut, for example, switches the Program (on air) output of the switcher instantly from the picture selected on the Program bus to the picture selected on the Preset bus. A cut can also be used to switch a key on or off air instantaneously.

Mix Transition

A *mix* is a transition from one picture to another where the new picture mixes into and then replaces the picture that was already on air (Figure 2-1). The Model 1200 allows you to mix from one background picture to another or to mix up to three separate key layers on or off over a background. Background and effects key mixes can be done separately or simultaneously.

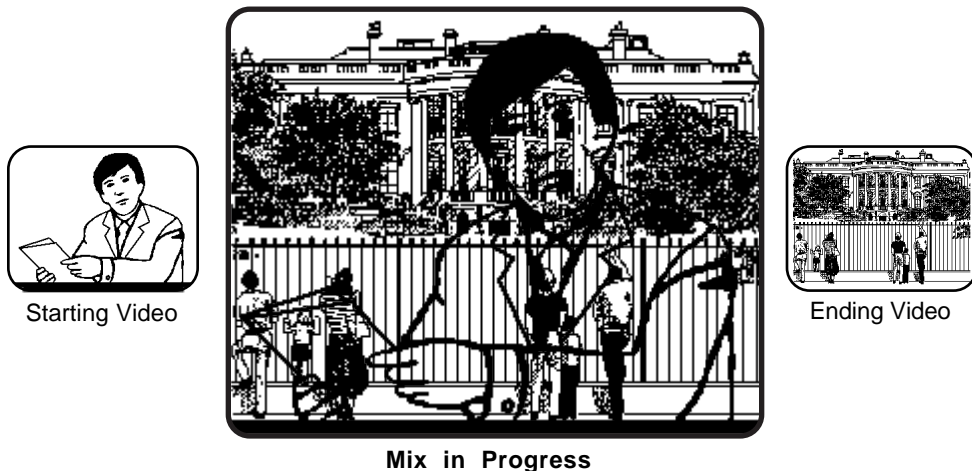

Figure 2-1. A Mix Transition

Wipe Transition

A *wipe* is a transition from one picture to another where a shaped edge moves across the screen revealing the new picture (see Figure 2-2). A background wipe removes the old Program Background picture as it wipes on the new Preset Background picture. A key wipe reveals the key over the existing background or removes it without affecting the existing background. In the Model 1200, a wipe can also change the background and the effects key(s) at the same time.

Wipes can take the shape of any of the twenty available patterns, which can be adjusted for position, aspect ratio, multiples, rotation, modulation, edge width, edge color, and edge softness.



Figure 2-2. A Wipe Transition

Key

A key is an effect in which parts of one picture are inserted into another to create a composite picture. For example, keys are used to insert captions, to place a small news scene or graphic over the shoulder of a newscaster, or to place the image of a weather reporter in front of a weather map. There are several types of keys, each of which serves a different purpose.

Luminance Key

A *luminance key*, shown in Figure 2-3, uses the brightness information in one picture, called the *key source* to cut a hole in another picture, called the *background*. A third picture, called the *fill*, is inserted into the hole to fill it. A *clip* control allows the operator to set the level of key source brightness that will cut the hole so that any part of the picture that is lower in brightness than the clip setting is ignored and will not cut the hole. The operator can also *invert* the key so that dark areas of the source cut the hole instead of bright areas.

To use an example, suppose we want to insert a green logo into some background video. We could print the logo in white on black paper and then focus a camera on it. We can then apply the signal from the camera to the switcher's keyer where it will be used as a key signal. Next we can select a green matte video to apply to the keyer as the fill video. When the clip is set properly, the keyer will ignore the black paper and use only the white logo shape to cut a hole in the background video. Then it will fill the logo-shaped hole with green matte video. This creates a green logo inserted into the background. In actuality, this method of keying is seldom used anymore. Instead, a graphics system generates the key and fill video, but the same concepts apply.

Luminance keyers also include a *gain* control, which sets the sharpness of the transition from one picture to another at the key's edge; high gain yields a sharp edge, and low gain yields a soft edge that mixes the fill and background video. In addition, the Model 1200 keyers include an S-shaping function that prevents the transition at the key edge from becoming too sharp and creating what appears to be a band or line around the key.

Using the Keyer menu, the clip and gain controls can be changed to control foreground clip and background clip. In that case, the controls independently adjust the transition edges of the foreground fill video and the background video.

Linear Key

A *linear key* is similar to a luminance key except that the gain of the key is set to a value of one (also called “unity”) so that the edges of anti-aliased key sources are faithfully reproduced. Anti-aliased sources, such as the output of a character generator or graphics system, have soft edges that produce a mix between the fill and the background at the key edge. A linear key preserves this edge.

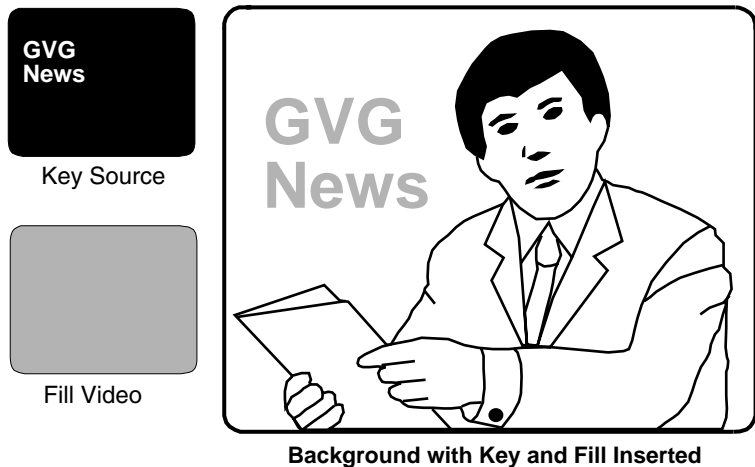

Figure 2-3. Luminance Key Example

Preset Pattern Key

A *preset pattern key* or *preset wipe* is a key in which the shape of a wipe pattern cuts the hole in the background video. The fill video is selected on the Key bus, and the Pattern controls and Wipe menus are used to select and adjust the key source pattern.

Chroma Key

A *chroma key* is a key in which a particular color that you select in the background of a scene is detected and replaced with a new background scene. This gives the illusion that foreground objects are positioned in front of a new background. For example, the fill video selected on the Key bus may be a weather reporter standing in front of a blue wall, and the new background video may be a weather map (Figure 2-4). The completed chroma key consists of the weather map background where the blue wall used to be and the reporter foreground fill everywhere else. This creates the illusion that the reporter is standing in front of the weather map.

A convenient feature of the 1200 chroma keyer is automatic setup, which sets up the key for you when you identify the background color that you want to replace by positioning a cursor over the color using the joystick and pressing the button on the top of the joystick. In most cases, this function yields a very good chroma key, which you can use as is or fine tune as desired using the Keyer controls and the Chroma Key menu controls.

The Model 1200 chroma keyer includes background and foreground suppression. Background suppression replaces the old background color with black before adding in the new background. This ensures that the old background color is completely removed from the scene, resulting in a cleaner key. Foreground suppression is essentially a second chroma keyer that allows you to detect and remove the background color and its variations that “splash” onto foreground objects, as sometimes happens when the foreground object is placed near the background. The detected foreground “splash” color is replaced with a neutral color and luminance value that restores the natural color of the foreground object.

Both background and foreground suppression include menu controls for selecting the hue to be replaced and for adjusting the luminance and chrominance levels in the areas of the picture where suppression is applied.

Also included in the 1200 chroma keyer are a shadow processor and a box mask. The shadow processor adjusts the amount of shadow that chroma key foreground objects cast onto the background, making the key look more natural. The box mask, controlled from the Chroma Key Force Mask menu, can be sized and positioned over a part of the key foreground or background to prevent the key from occurring in that area.

Lastly, an Edge Control menu allows you to adjust the size (both width and height) of the key edge in the black suppressed part of the background. Adjusting for optimum key size ensures that none of the black background suppression is visible along the key edges.

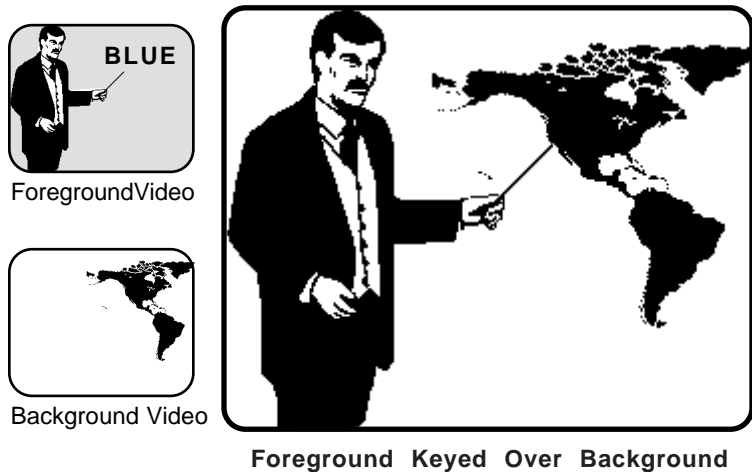

Figure 2-4. Chroma Key Example

Shaped Video

Shaped video is video that has been multiplied by a key signal to create a partial-raster image that is matted over black. A good example of shaped video is the fill video output of some character generators, which consists of characters on a black matte. Typically, the shaped fill video is also accompanied by a matching key signal that may be used in a keyer to cut a hole in background video into which the already-shaped fill video may be inserted.

The 1200 configuration menus ask you to identify video inputs as shaped or unshaped because the switcher handles those two types of fill video signals differently. For keying with shaped fill video, the keyer multiplies only the background video with the key signal to cut a hole in the background, and then adds the already-shaped fill video into the hole. For fill video that is not already shaped, the keyer first multiplies both the background and the fill video with the key to cut a hole in the background and shape the fill to match the hole. Then the background video and the fill video are added together to create the finished key.

If you incorrectly identify the type of fill video in the Define Inputs configuration menu, selecting shaped when you should select unshaped or vice versa, your keys will have dark lines at the edges or other artifacts. Changing the video type in the Define Inputs configuration menu will correct the problem.

Effects Send

Effects Send provides a close interface between the switcher and a digital picture manipulator (DPM). Effects Send takes the key and fill video outputs of an effects keyer and sends them to the DPM for manipulation. The manipulated key and fill outputs from the DPM then re-enter the switcher's mixers via the aux buses.

The Effects Send advantage lets you transform a switcher key effect, such as a chroma key or a preset pattern, as though the DPM circuitry were built into the middle of the switcher: The transformed key can be layered over a switcher background and additional keys can be layered on top of the transformed key.

Z-Key™ Depth

The Depth option enables the switcher's two effects keyers to key a depth key input from a Grass Valley digital picture manipulator over a switcher background. Depth keying creates an effect in which one key layer appears closer to the viewer than a second key layer does, and one key layer can "slice" through the other.

The Depth option also works with ordinary key signals. You can assign different depth values to the two M/E keys and record them. Then you can play the composite effect back and insert additional key layers between the original two layers. The keys cannot be made to intersect, and they may not create the visual illusion of depth the way a true depth key does, but you can composite multi-layered graphics with layers that slide in and out between other layers.

In order to record a depth key, a 10-bit digital recorder with two channels (video and key) is required to retain depth information.

E-MEM® Effects Memory

E-MEM Effects Memory provides a way of storing switcher effects for later use. With E-MEM you can set up an effect and "learn" a snapshot of it into memory. Later, you can recall that effect at the touch of a button, and the switcher will immediately return to the state it was in when the effect was learned.

You can also learn automatic transitions as part of a stored effect. When you learn an auto transition with an effect into a register, recalling that register recalls the effect first, and then starts the stored transition automatically.

The E-MEM system includes 20 effects storage registers arranged in two "banks" of ten registers each. E-MEM register contents can be saved to disk using the floppy drive and menu display.

System Setup: Using the Configuration Menus

The following procedures allow you to configure the 1200 system to your installation. Using the Configuration menus in the menu display, you can assign sources to the crosspoints, configure the inputs, set output levels, adjust system timing, and set other system parameters. These menu items are accessed through the Configuration menu (Figure 2-5) on the Menu Display subpanel.

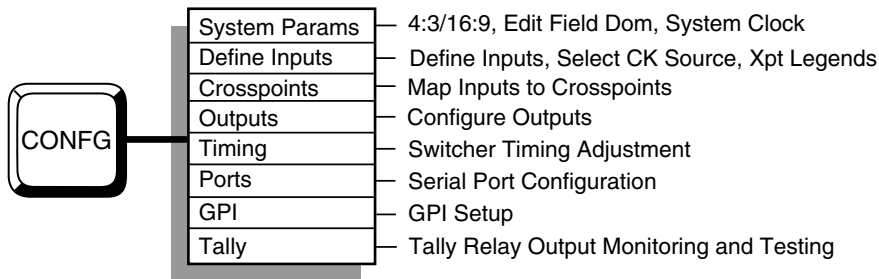

Figure 2-5. 1200 Configuration Menu Tree

Menu Pushbuttons and Knobs

The display panel includes pushbuttons and knobs that work interactively with the display menus to control the switcher:

- The white menu “hot buttons” at the left of the display activate the top level menus.
- The black buttons and knobs surrounding the display are “soft” buttons and knobs that change function with each menu. Labels displayed along the bottom and right edges of each menu indicate the functions of the soft controls. The “>” display symbol indicates a lower level menu that you can view when you press the associated soft button.
- Double-pressing one of the soft buttons next to the soft knobs restores the associated knob function to its default value.
- The [Exit] button takes you up one menu level.

Configuration Menu

The Configuration menu (Figure 2-6) and its sub-menus allow you to set up the switcher to meet your requirements. To begin the setup process, press the **[Config]** button next to the menu display to bring up the Configuration menu, which includes the following sub-menus and functions.

[SYSTEM PARAMS>] —4:3/16:9 Picture Aspect, Editor Field Dominance, and System Clock.

[DEFINE INPUTS>] —Define Inputs, Chroma Key Sources, and Crosspoint Legends.

[XPT MAP] —Map physical inputs to crosspoints.

[OUTPUTS>] —Configure Outputs.

[TIMING>] —Switcher Timing.

[PORTS>] —Serial Port Configuration.

[GPI>] —GPI Setup.

[TALLY>] —Tally Relay Setup.

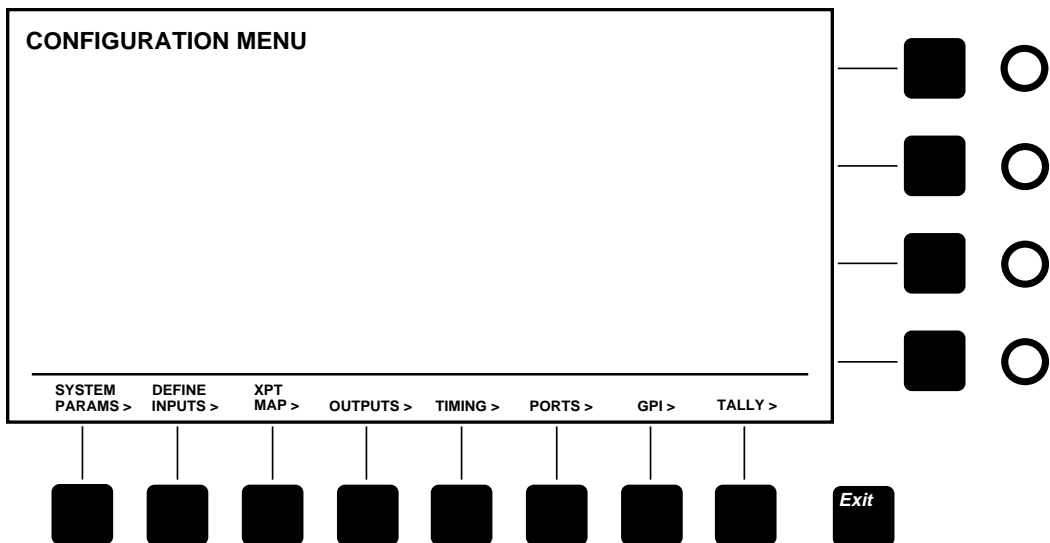

Figure 2-6. Configuration Menu

System Parameters Menu

Use the System Parameters menu (Figure 2-7) as explained below to set the aspect ratio (ratio of television picture width to height), to set the field dominance for use with an editor, and to set the system clock.

1. Press the **[SYSTEM PARAMS>]** soft button to display the System Parameters menu.
2. Use the **[VIDEO ASPECT]** soft button to highlight the selection that reads **4:3**. Press the button to switch between **4:3** and **16:9**.
3. If appropriate, change the Field Dominance using the **[EDITOR FLD DOM]** soft button. Setting Field Dominance to **ODD** or **EVEN** ensures that transitions always take place during a particular color field. Some editing systems may require a particular selection; see your editor manual for details. The default is **BOTH** fields.
4. Set the date by selecting **DATE** with the **[SELECT]** soft button and turning the soft knobs to select the appropriate **(YEAR)** , **(MONTH)** , and **(DAY)** . When the date is correct, confirm it using the **[CONFIRM DATE]** soft button.
5. Set the time by selecting **TIME** with the **[SELECT]** soft button and turning the soft knobs to select the appropriate **(HOURS)** , **(MINUTES)** , and **(SECONDS)** . When the time is correct, confirm it using the **[CONFIRM TIME]** soft button.

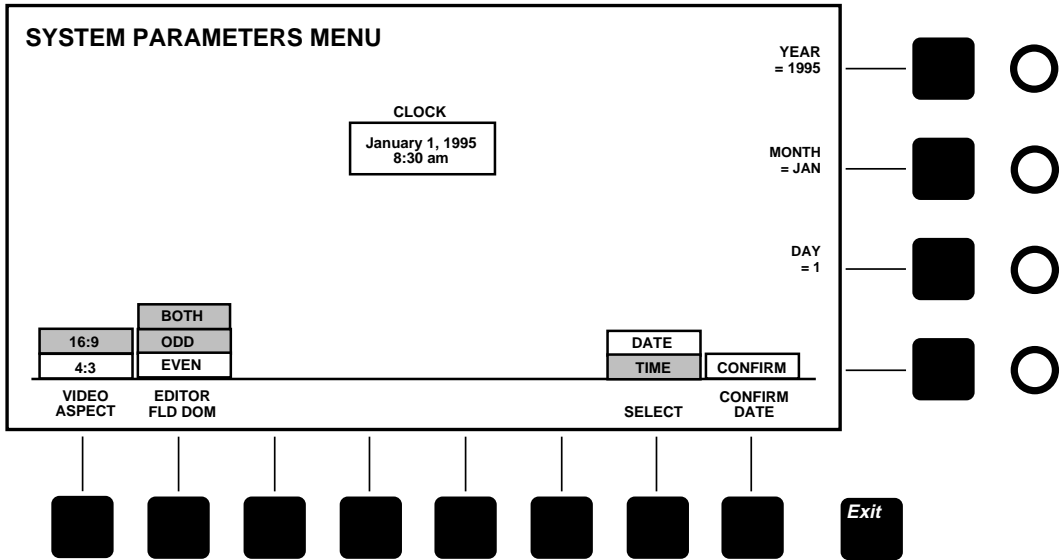

Figure 2-7. System Parameters Menu

Define Inputs Menu

From the Configuration menu select **[DEFINE INPUTS>]** to display the Define Inputs menu (Figure 2-8). This menu is typically configured during switcher installation. However, you may want to change configurations for different types of production sessions. The Inputs menu allows you to do the following:

- Give each physical input a descriptive name which is carried forward into several other menu levels.
- Attach characteristics to each physical input, such as bit resolution of the source, identification of the signal type, and association of key cutters with fills. The signal type tells the switcher whether the input is to be treated as video, shaped video, key, or key with depth.
- Designate a video/key pair as the return inputs in systems where an effects send and return will be used. This information is needed by the switcher for automatic switching of the effects loop. (See the explanation of Effects Send later in this section for details.)
- Select 4:2:2 chroma key inputs or full-bandwidth 4:4:4 chroma key inputs. Two physical inputs are needed to accommodate a full-bandwidth chroma key signal. The Inputs/4:4:4 CK Sources sub-menu designates those two physical inputs.
- Associate a four-character legend with each physical input. These legends appear in the Inputs menu and also in the LED displays that may be installed between the Key and Aux crosspoint pushbutton rows.

Define Inputs

Using the Define Inputs menu, define each input as follows:

1. Select a Physical Input using the **(PHYSICAL INPUT)** soft knob. The physical input numbers are the same as the jack numbers on the back of the electronics frame.

2. Enter a Signal Name by pressing the **[CLEAR NAME]** soft button, typing a name on the keyboard, and pressing the **[ENTER NAME]** soft button.
3. Using the **[BITS]** soft button, identify the input as either an 8 or 10 bit signal.
4. Using the **[TYPE SELECT]** soft button, identify the input type: **DEPTH** (depth key signal from a digital picture manipulator), **KEY**, **SHAPED** (video shaped by a key), or **VIDEO** (unshaped).
5. Assign the Effects Return Flag to a video and a key source by highlighting them and pressing **[EFX RTN FLAG]**. This identifies that video/key input pair as the Effects Send signals returning from a Digital Picture Manipulator. When Effects Send is on, the switcher will automatically select these inputs.
6. Assign an Auto Select key input to a video fill input using the **(AUTO SEL KEY SRC)** soft knob. Auto Select provides automatic selection of the associated key input when you select the fill input on the Key crosspoint bus.

DEFINE INPUTS MENU

PHYSICAL INPUT	SIGNAL NAME	BITS	TYPE	EFFECTS RETURN	AUTO SEL
J1	VTR 1	10	VIDEO		
J2	CHAR GEN VID	10	SHAPED		J3
J3	CHAR GEN KEY	10	KEY		
J4	VTR 2	10	VIDEO		
J5	VTR 3	8	VIDEO		
J6	R-VTR	8	VIDEO		
J7	DPM-700 KEY	10	KEY	KEY	
J8	DPM-700 VIDEO	10	SHAPED	VIDEO	J7

DEPTH
KEY
8
10
SHAPED
VIDEO

CLEAR NAME	ENTER NAME	BITS	TYPE SELECT	EFX RTN FLAG	4:4:4 CK SOURCES >	XPT DISP LEGENDS >
------------	------------	------	-------------	--------------	--------------------	--------------------

PHYSICAL INPUT = J2

AUTO SEL KEY SRC = J3

Exit

Figure 2-8. Define Inputs Menu

Chroma Key Sources Menu

Display the 4:4:4 Chroma Key Sources menu (Figure 2-9) by selecting **[4:4:4 CK SOURCES>]** from the Define Inputs menu.

To assign a 4:4:4 video fill to the Chroma Keyer, use the soft knobs:

1. Select the Physical Input source for channel A by using the **(4:4:4 CK CHANNEL A)** soft knob.
2. Select the Physical Input source for channel B by using the **(4:4:4 CK CHANNEL B)** soft knob.

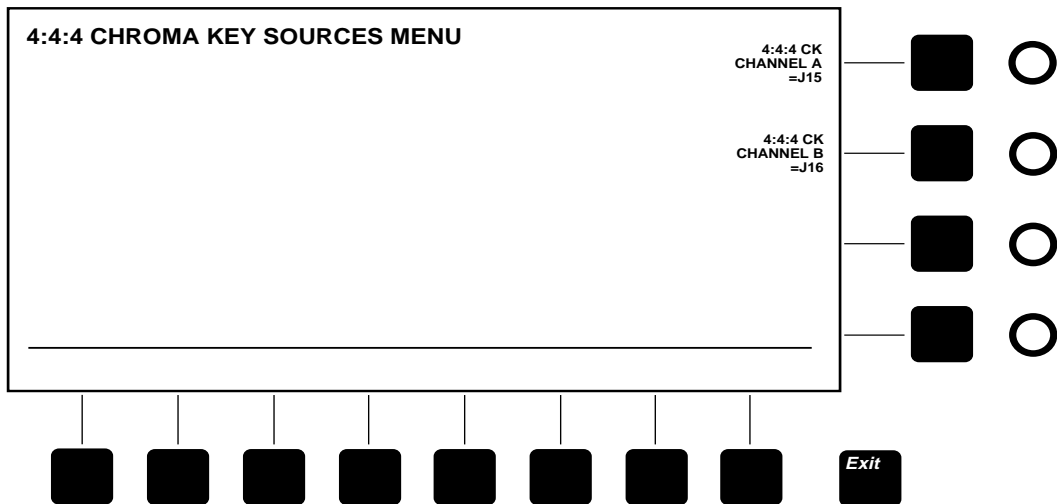

Figure 2-9. 4:4:4 Chroma Key Sources Menu

Crosspoint Display Legends Menu

Display the Crosspoint Display Legends menu (Figure 2-10) by selecting **[XPT DISP LEGENDS>]** from the Define Inputs menu. This menu allows you to assign a unique name (up to 4 characters) to each physical input. The name will display above the crosspoint column to which that physical input is mapped.

1. Use the **(PHYSICAL INPUT)** soft knob to select a Physical Input. The Signal Name column displays the descriptive name of the selected Physical Input. (Signal Name is created in the Define Inputs menu.)
2. To enter a new Local Name, select Local using the **[LEGEND MODE]** soft button, press the **[CLEAR LOCAL]** soft button, type a descriptive name using the keyboard, and press the **[ENTER LOCAL]** soft button.

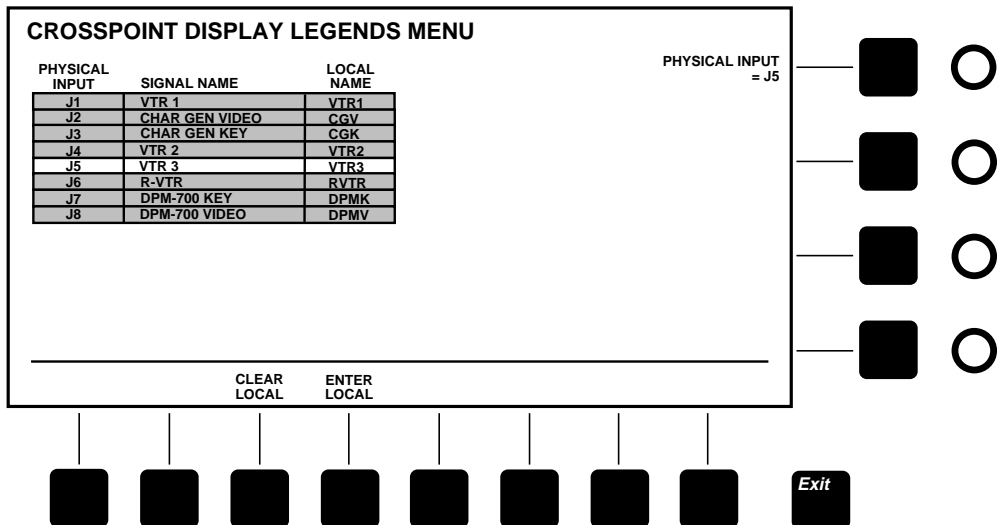

Figure 2-10. Crosspoint Display Legends Menu

Crosspoint Map Menu

The Crosspoint Map menu (Figure 2-11) is displayed by pressing the **[Config]** button and then the **[XPT MAP>]** button.

1. Set the **[XPT MAP SELECT]** soft button to the **NORMAL** or **ALTERNATE** crosspoint map. Using this function, you can define two completely different crosspoint maps and switch between them as desired. If you plan to use only one map, select **NORMAL**.
2. Use the **(XPT)** soft knob to select the crosspoint to be highlighted.
3. Use the **(PHYSICAL INPUT)** soft knob to assign a Physical Input to the highlighted crosspoint. The Signal Name column will display the descriptive name of the selected Physical Input. (Signal Name is created in the Define Inputs menu.)

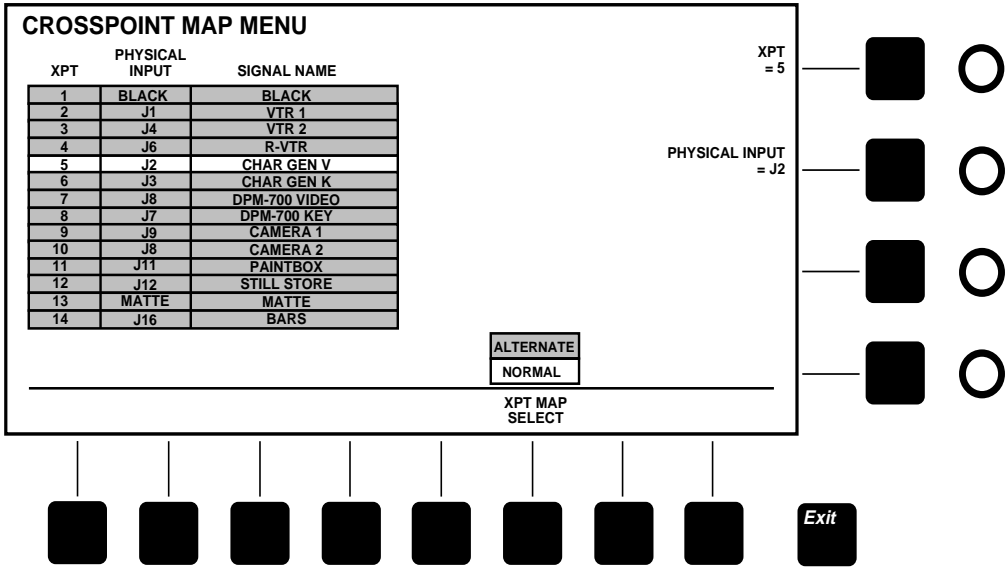

Figure 2-11. Crosspoint Map Menu

Outputs Menu

From the Configuration menu, select **[OUTPUTS>]** to display the Outputs menu (Figure 2-12). This menu allows you to set up signal formats for Model 1200 outputs.

1. Use the **(OUTPUT)** soft knob to highlight the name of the output to be configured.
2. Use the **[BITS RES]** soft button to select either 8 or 10 bits to match the bit resolution of your output destination.
3. Use the **[SHAPING]** soft button to turn shaping **ON** or **OFF** for that output. Shaping **ON** produces a video output shaped by the key signal and matted over black. (Shaping for the Program and Preview DAC outputs follows the Program 1/2 or Clean Feed output shaping selection.)
4. Use the **[SIGNAL SOURCE]** to select either **CLEAN** (clean feed; video with no key) or **PROGRAM** (video with key).

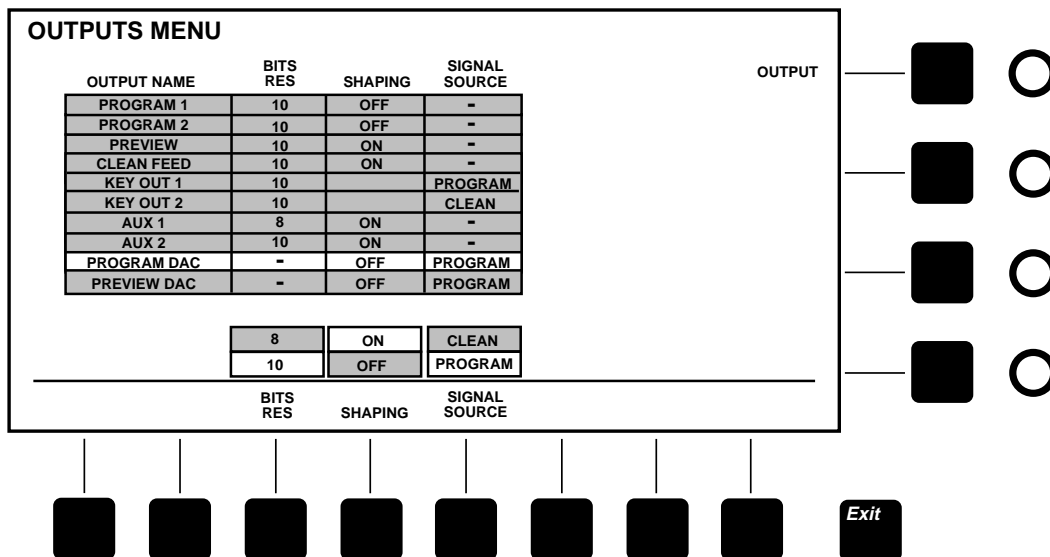

Figure 2-12. Outputs Menu

Timing Menu

Input timing is automatic; however, you can adjust the overall timing manually in the Timing menu (Figure 2-13) to ensure that auto-timing captures all inputs. When you make this adjustment, you are advancing or delaying the Reference input, which causes a corresponding movement of the auto-timing capture window for the primary inputs and also causes a corresponding movement of the switcher outputs.

To adjust the overall timing, use the **[COARSE]** soft knob to set a rough timing value, then adjust the **[REF TIMING (FINE)]** soft knob to fine tune the timing. The maximum timing range is ± 330 clocks (a clock equals 69.84 nanoseconds).

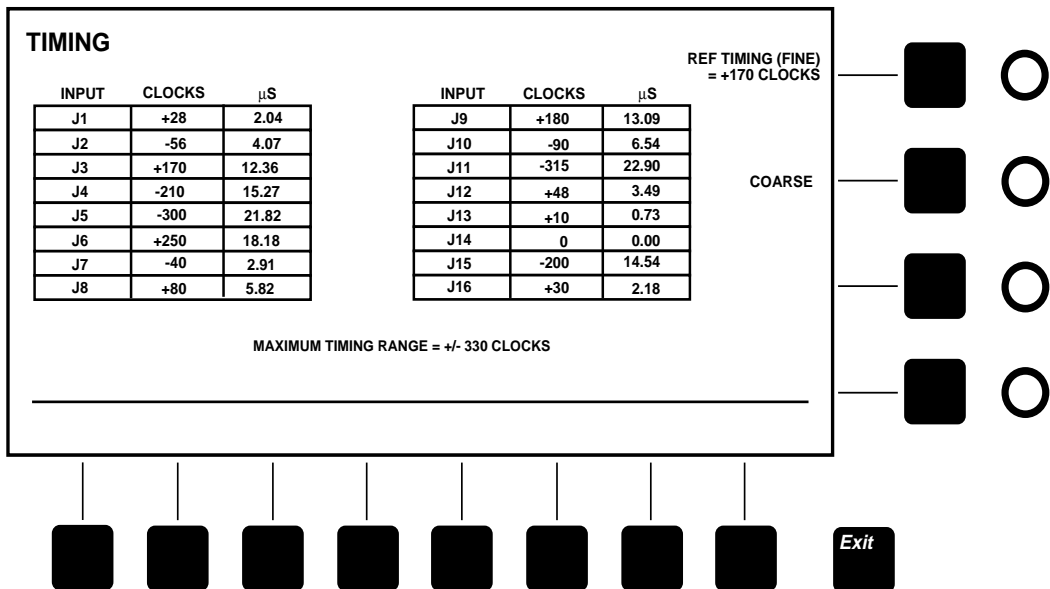

Figure 2-13. Timing Menu

Port Menu

The Port Configuration menu (Figure 2-14) is displayed by pressing the **[Config]** button on the main subpanel and then the **[PORTS>]** soft button.

1. Use the **(PORT)** soft knob to highlight the port you wish to configure. (Ports are listed in the left-most display column.)
2. Use the **(PROTOCOL)** soft knob to select the protocol for the port. Protocol settings for typical equipment are listed below:

Panel Port —Already set for **1200 PNL** protocol (RS-422, address 30H, 38400 baud, 8 bits, 1 stop bit, odd parity). Cannot be changed.

Terminal (TTY) Port —Use **TERMINAL** protocol (RS-232, 9600 baud, 8 bits, 1 stop bit, no parity).

Modem Port —Use **MODEM** protocol (RS-232, 2400 baud, 8 bits, 1 stop bit, no parity).

DPM-100/700 Port —Use **DPM** protocol (RS-422, address 30H, 38.4 K baud, 8 bits, 1 stop bit, odd parity).

Editor Port —Use Grass Valley **1200** (address 30H). Communication is RS-422, 38.4K baud, 8 bits, 1 stop bit, odd parity. You may also use **110** or **200** switcher protocol if your editor does not have a 1200 interface, but functionality will be reduced.

Aux Satellite Panel Port —Use **200** or **1200 AUX** protocol (RS-422, 9600 baud, 8 bits, 1 stop bit, no parity). Any available port may be used for the Aux Satellite Panel.

3. If assigning a particular protocol does not yield the correct communication parameters, you may highlight and change those parameters individually. Use the **(ADDRESS)** and **(BAUD RATE)** soft knobs and the **[BITS]**, **[PARITY]**, and **[STOP BITS]** menu buttons.
4. The **[FACTORY DEFAULT]** soft button resets the selected port to its factory-assigned protocol.

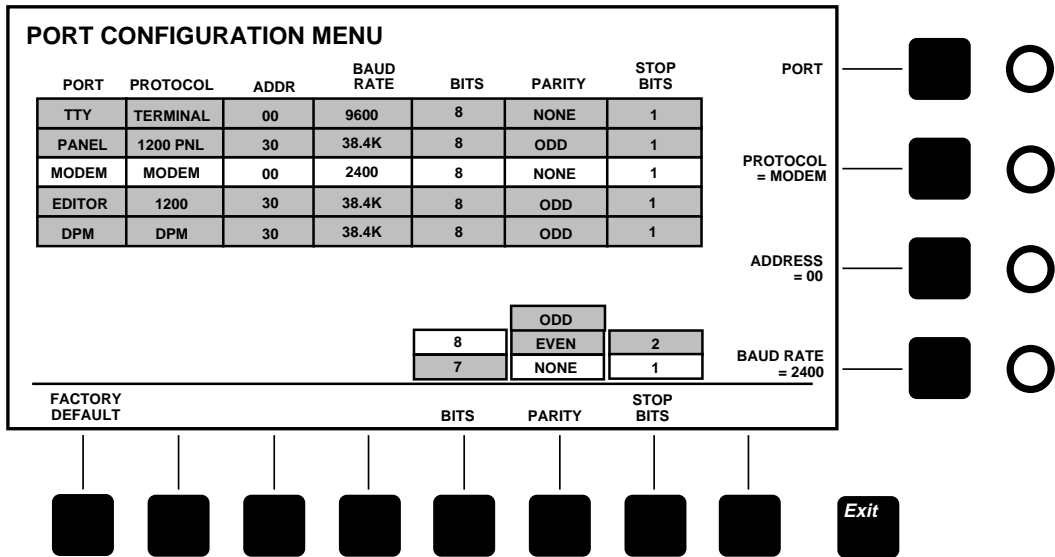

Figure 2-14. Port Configuration Menu

GPI Menus

The GPI Inputs menu (Figure 2-15) is displayed when you press the **[Config]** top menu button followed by the **[GPI->]** soft button. From this menu, you can view the GPI Inputs or access the GPI Outputs menu (Figure 2-16). Together, these two menus allow you to assign, view, and test the 8 GPI inputs and 8 GPI outputs.

GPI inputs are trigger signals that come from external equipment (via the GPI connector at the back of the frame) and start a specified event in the switcher, such as an auto transition. GPI outputs are trigger signals generated by switcher events that go out via the GPI connector to external devices to cause them to take some action. You can assign events to the GPI Inputs or Outputs as follows:

1. Display the GPI Input or Output menu.
2. Change the event assigned to a GPI using the **(SELECT GPI INPUT/OUTPUT)** soft knob to highlight the desired input or output.

Use the **(SELECT EVENT)** soft knob to assign an event to the

3. Highlighted GPI.

Two events deserve special mention. The **ALTERNATE XPT MAP** selection allows you to use a GPI input to switch between two different crosspoint maps stored in the Input Map menu. This can be convenient when you have two different uses for the switcher, for example, a live news show and off-line post production. The **AUX BUS TALLY BACK** selection uses the GPI as an input condition that the switcher detects in order to tally the selected aux bus crosspoint. This permits an external DPM to tally the aux buses when aux bus video is on air at the DPM. Aux tallyback can be turned on and off in the Tally menu.

When set to **ON**, the **[GPI OUTPUT TEST]** soft button in the GPI Outputs menu cycles through the GPI outputs, closing each relay for approximately 1/2 second, allowing you to verify GPI operation. When finished testing, set the button to **OFF**.

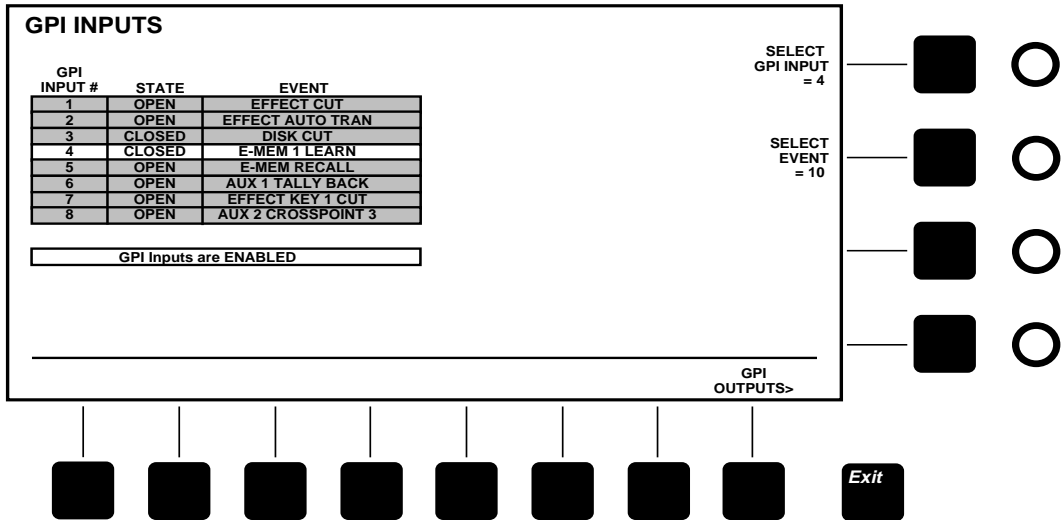

Figure 2-15. GPI Inputs Menu

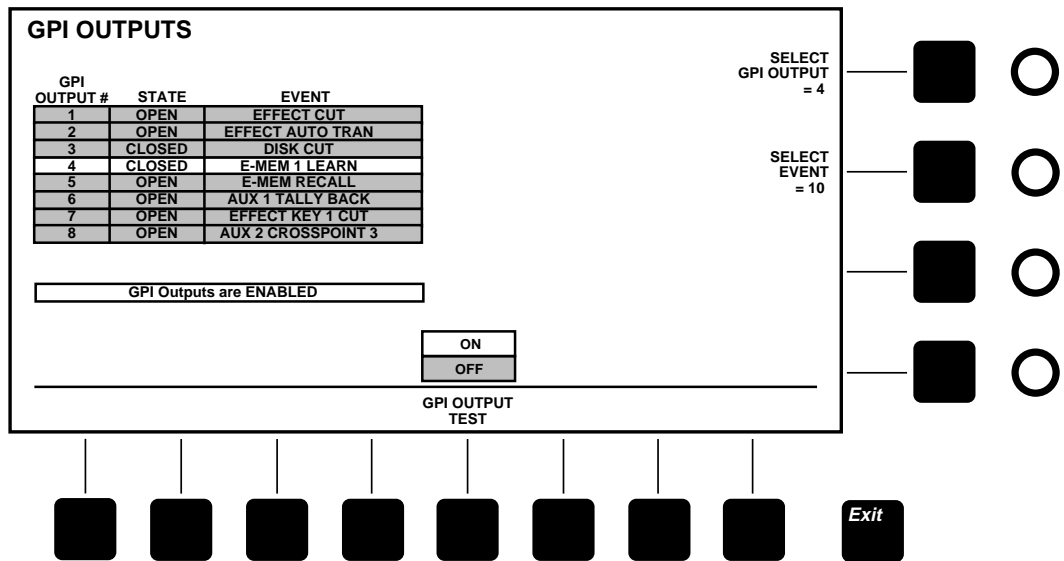

Figure 2-16. GPI Outputs Menu

Tally Menu

The Tally menu (Figure 2-17) displays a table listing the 16 physical signal inputs, indicating those that are high-tallied by highlighting them.

The **AUX TALLY BACK** (Aux Bus Tally Back) **ON/OFF** selection, when set to **ON**, allows use of a GPI to tally Aux Bus 1 whenever the effects send fill crosspoint is tallied and Aux Bus 2 whenever the effects send source crosspoint is tallied. This provides tally back for an external DPM without requiring a tally back input from the DPM. To use this feature, it must be enabled in the Tally menu and assigned as an event to a GPI input in the GPI Inputs menu.

The **TALLY TEST** selection allows you to test the tally output relays. To test all of the tally outputs, set the **[TALLY TEST]** soft button to the **ON** position; this cycles each output on for about 1/2 second. When finished testing, set the button to **OFF**.

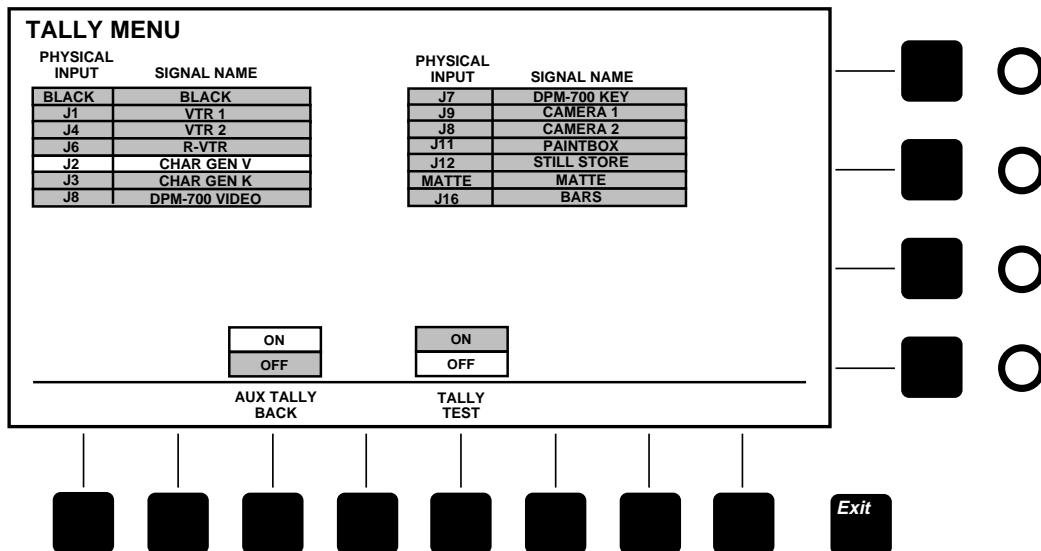

3

Controls & Menus

Introduction

This section describes the Model 1200 control panel, covering each panel control in detail. Controls are grouped by panel sections, which are presented in alphabetical order as listed below:

- Bus Delegates—page 3-4
- Crosspoint Buses—page 3-5
- Downstream Keyer (DSK)—page 3-9
- Effects Send—page 3-11
- E-MEM—page 3-12
- External I/F—page 3-15
- Fade To Black—page 3-16
- Keyer—page 3-17
- Matte—page 3-26
- Pattern—page 3-28
- Readout Display Options—page 3-116
- Transition—page 3-32
- Visual Display and Menus—page 3-36

For your reference, Figure 3-1 shows the control panel.

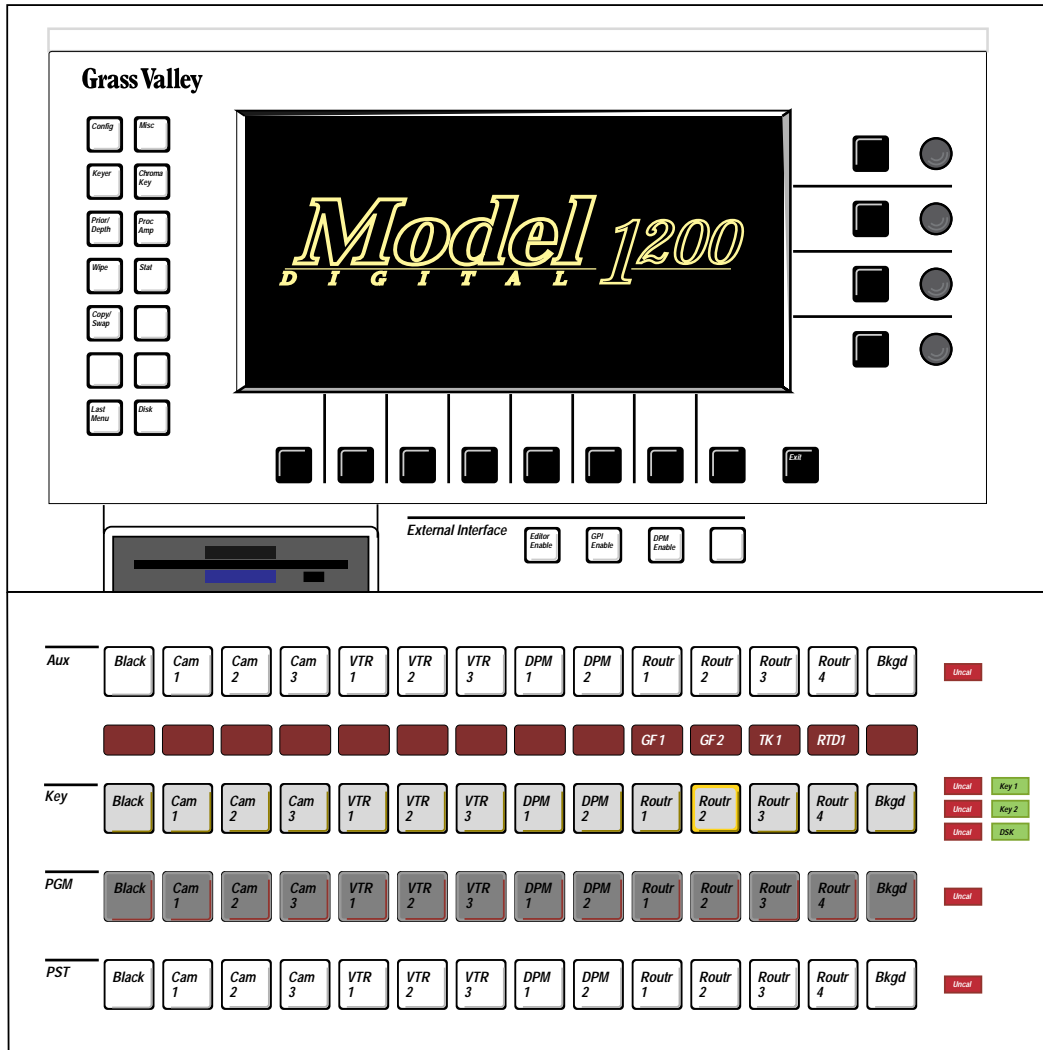

Figure 3-1. Model 1200 Control Panel

Matte

Lum Sat Hue Opacity

Bkgd Fill Preset Border Border Line

Wipe Border Key 1 Key 2 DSK

BKGD 14

Delegation

Pattern

Size Width Softness Symmetry

Mask/ Preset Invert Border Soft Symm

Mask/ Preset Pattern Wipe

Keyer

Normal Border Shadow Extend Outline

Key Over Mask Invert

Video Fill Matte Fill Video Key Auto Select Key

Linear Key Luma Key Chroma Key Preset Pattern Split Key

Auto Setup

Key 1 Key 2 DSK Key On Cut

Key Opacity Gain Clip

Wipe Direction

Normal Reverse Flip/Flop

User 1 User 2 User 3 User 4 Menu

Learn User Wipe Undo

WIPE

Pos Center

Effects Send

Key 1 Key 2 DSK

Bus Delegates

Aux 1 Aux 2

Fade To Black

Black Cut Black Mix

Black On **60**

E-MEM

15

Learn 7 8 9

4 5 6

Bank 1 2 3

Bank 0 Undo Enter

+/-

Clear ME Trans DSK Trans Black Trans

Transition

Bkgd Key 1 Key 2

Key On Key On Over Over

Mix Wipe Trans Preview

Cut Auto Trans **60**

DSK

DSK Preview

DSK On **60**

DSK Cut DSK Mix

3-3

Bus Delegates

The Bus Delegates section of the panel (Figure 3-2) includes the [AUX 1] and [AUX 2] pushbuttons, representing the two internal Auxiliary crosspoint buses. When you select one of these buttons, the Aux crosspoint row delegates to control the selected bus. Only one of the Aux buttons may be on at a time. Also, turning on an Aux Delegate button cancels Effects Send if it was on.

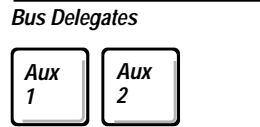

Figure 3-2. Bus Delegates Panel

Crosspoint Buses

The crosspoint buses include crosspoint buttons for selecting video and key sources for backgrounds, keys, and auxiliary bus outputs. See Figure 3-3 on page 3-6. The crosspoints operate as follows:

- Video and key input sources are “mapped” or assigned to crosspoint columns in the Config/Crosspoint Map menu. In addition, inputs are defined and assigned names in the Config/Define Inputs menu.
- To select an input on any bus, press the [CROSSPOINT]. The selected input will be routed to the bus output.
- Crosspoints light brightly (high tally) when contributing to the on-air Program picture. They light dimly (low tally) when selected but not on-air.
- Each crosspoint can generate its own internal matte instead of selecting a video or key signal, if so assigned in the configuration menus. To adjust the color of a BKGD or matte, press the [CROSSPOINT] button to delegate the Matte controls and then adjust the Matte controls for the desired color.
- Each crosspoint bus includes an adjustable signal processing amplifier if enabled in the configuration menus. When you double-press a video or key crosspoint, the Proc Amp menu appears, allowing you to adjust signal levels for that video or key source. As you adjust levels, the UNCAL lamp at the end of the bus lights to indicate that the proc amp is no longer at the default unity setting. To reset the proc amp to the default unity setting, press the [**CLEAR PROC AMP**] menu button, or hold the crosspoint button down and press the [CLEAR] button in the E-MEM panel area.

PST (Preset) Bus

PST bus crosspoints select the background video that will be placed on air by the next background transition.

PGM (Program) Bus

PGM bus crosspoints select the background video that is on air at the switcher's Program output.

- You can select a PGM crosspoint directly; this causes an immediate cut to the new video.
- Or you can select a source on the PST bus and then do a background transition to transfer the Preset selection to Program.

At the end of a background transition the PGM and PST selections “flip-flop”—the PST source transfers to PGM, and the PGM source transfers to PST.

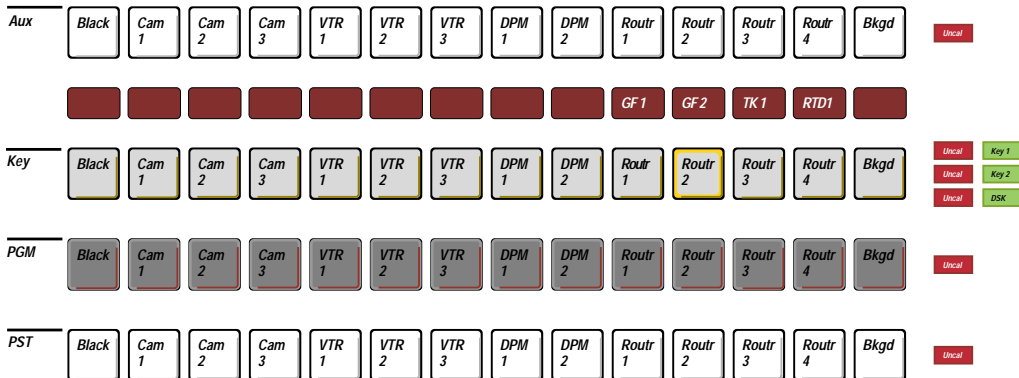

Figure 3-3. Crosspoint Buses

Key Bus

Key bus crosspoints select the fill video and key source used by the delegated keyer to create a key. Each crosspoint can be assigned a fill video and a key source via the configuration menus.

- Before selecting a crosspoint, you must first delegate a keyer by pressing the [KEY 1], [KEY 2], or [DSK] button in the Keyer or Transition section. Then select a crosspoint and make any other desired Keyer selections and adjustments.
- When [VIDEO KEY] is on, the switcher does a self key: the fill video you select on the Key bus also serves as the key source (cuts the hole and fills it).
- When [AUTO SELECT KEY] is on, you select the fill video crosspoint on the Key bus, and the switcher will automatically select the assigned key source.
- You can also do a split key (use different fill and source crosspoints): Select a Key bus fill [CROSSPOINT], hold down the [AUTO SELECT KEY] or [VIDEO KEY] button, and select another Key Bus [CROSSPOINT] to serve as the key source. The fill button and SPLIT KEY lamp light up and remain lit; the source crosspoint lights whenever you hold down the [AUTO SELECT KEY] or [VIDEO KEY] button.

A split key is temporary and does not change the key assignments mapped in the configuration menus during system setup. To cancel the split, press any Key bus [CROSSPOINT] or hold down [Auto Select Key] or [Video Key] and press the fill [crosspoint].

- Every Key bus crosspoint has Key Memory, if enabled in the Keyer menu. When you select a crosspoint, Key Memory restores the last keyer setup used for that crosspoint. Remembered functions include key source type (Video or Auto); key type (Linear, Luma, Chroma or Preset Pattern); and the various control knob and menu settings.

Aux Bus 1 and Aux Bus 2

The single row of Aux bus crosspoint pushbuttons controls two separate auxiliary crosspoint buses, Aux bus 1 and Aux bus 2. The Bus Delegate buttons control delegation of the aux row to control Aux bus 1 or Aux bus 2. After delegating the Aux row to the desired Aux bus, selecting a crosspoint in the Aux row causes the corresponding Aux 1 or Aux 2 bus output to cut to new video.

When one of the Effects Send buttons is selected, the Bus Delegate buttons turn off, and both aux buses become dedicated to the Effects Send signals. The Aux buses then serve as the return input path for preprocessed switcher video and key signals that have been looped through an external digital picture manipulator before entering the keyer. The switcher automatically selects the correct aux crosspoints according to the Effects Send crosspoint map assigned in the configuration menu.

Satellite Aux Bus Panels

When an optional Model 1200 or Model 200 Satellite Aux Bus Panel is connected to a switcher serial port and enabled in setup, the satellite panel has direct control over the aux buses. To select an aux crosspoint on the Satellite Panel, delegate an aux bus by selecting [AUX 1] or [AUX 2] and then select a Satellite Panel [CROSSPOINT]. Eighteen of the available Satellite crosspoints are assigned to the same video, key, black, and background inputs as the other switcher buses. The remaining crosspoints can have mattes assigned.

Downstream Keyer (DSK)

The DSK (Figure 3-4) inserts titles or other keys on top of the switcher's background and effects key layers. The DSK is a full-function keyer, capable of luminance, linear, chroma, and preset pattern keys just like the effects keyers.

- To delegate Keyer and Key bus controls to the DSK, select [DSK] in the Keyer section or select [DSK PREVIEW] on the DSK panel. The DSK lamp at the end of the Key bus will light.
- Select key fill and source [CROSSPOINTS] using the Key bus.
- Select and adjust key parameters using the Keyer controls.
- Transition the key on and off using the [DSK CUT] or [DSK MIX] button or using the [CUT] button in the Keyer section. When the key is on, the DSK ON lamp lights.

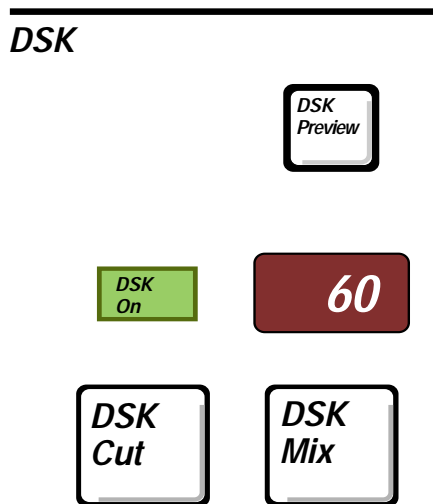

Figure 3-4. Downstream Keyer (DSK) Panel Section

DSK Preview

When you select **[DSK PREVIEW]**, the preview monitor option displays the downstream key over the current Program background, and the Keyer and Key bus delegate to the DSK.

DSK Cut

When you press the **[DSK CUT]** pushbutton, the downstream key immediately cuts on air (or off if it was already on).

DSK Mix

When you press the **[DSK MIX]** button, the downstream key mixes on over the Program output (or off if it was already on) at the frame rate shown in the DSK Transition Rate display. If you press the button a second time during a transition, the key transition will reverse.

Effects Send

The Effects Send panel section includes three buttons to enable the Effects Send option for any one of the three keys: [KEY 1], [KEY 2], or [DSK]. See Figure 3-5.

When you select an Effects Send keyer button, Effects Send mode turns on for the selected keyer, the Keyer controls delegate to the selected keyer, and the Aux buses delegate to Effects Send. Only one keyer can use Effects Send mode at a time. This mode routes the key and fill video outputs of the keyer outside the switcher to a digital picture manipulator (DPM), which transforms them and returns them to the switcher's mixer via the aux buses.

- To cancel Effects Send, press either of the Bus Delegates buttons, [AUX 1] or [AUX 2]. This turns off Effects Send and delegates the Aux row to the selected Aux bus.

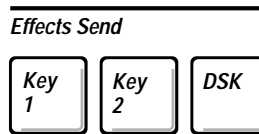

Figure 3-5. Effects Send Panel Section

E-MEM Effects Memory

Twenty E-MEM[®] effects memory registers store switcher effects and automatic transitions for later recall. The twenty registers are divided into two banks of ten registers each. See Figure 3-6.

Learn Button

The [LEARN] button places the E-MEM system in learn mode when lit and recall mode when off. At the end of a learn, the [LEARN] button turns off automatically.

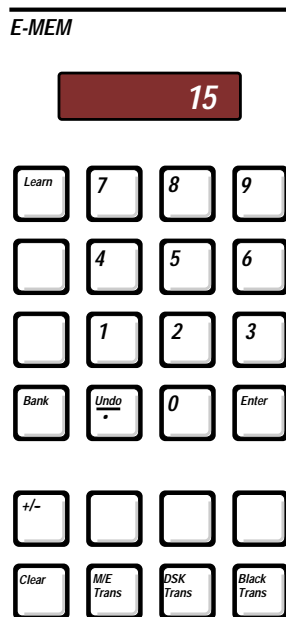

Figure 3-6. E-MEM Panel Section

Register Buttons

The ten register buttons, numbered 0–9, control the twenty panel-operated E-MEM storage registers and also serve as a numerical keypad. The register buttons operate as follows:

To learn (store) the current switcher setup into an E-MEM register, press [LEARN], press [BANK] and [0] or [1] if you need to change banks, and press a register button [0-9]. The current switcher setup will be stored in that register for later recall.

- To recall a stored setup, press [BANK] and [0] or [1] if you need to change banks, and then press one of the register buttons [0-9]. The setup stored in that register will be recalled.
- To learn one or more automatic transitions into a register:

Select [LEARN], press the transition functions you want to store (M/E TRANS, [DSK TRANS], or [BLACK TRANS]), press [BANK] and [0] or [1] if you need to change banks, and press one of the ten register buttons [0-9].

The transitions you specified will be stored in the register together with the current panel setup. When you recall the register, the panel setup will be recalled and then the transitions will occur at the rates present when learned.

Undo/Decimal Point

Pressing the [UNDO/.] button immediately after a recall, returns the switcher to the state it was in just before the recall occurred. Pressing [UNDO/.] again returns you to the recalled effect. Pressing [UNDO/.] repeatedly, toggles between the two states.

Pressing [UNDO/.] just after completing a learn restores the previous contents of the register affected by the learn.

Trans Buttons

Using the three Trans buttons, you can assign automatic transition rates for M/E, DSK, and Black transitions:

- Press one of the trans buttons: **[M/E TRANS]**, **[DSK TRANS]**, or **[BLACK TRANS]**. The E-MEM display will prompt you with “Trans =?”.
- Use the keypad to enter a transition rate in television frames.
- Press **[ENTER]** to confirm the new rate. The new transition rate should appear in the appropriate transition rate display.

Clear

- When used in conjunction with other buttons the **[CLEAR]** button resets the selected functions to their default values. To clear a function to its default values, hold down the button for that function and press **[CLEAR]**. If you double press the **[CLEAR]** button, the menu display brings up the Misc. menu.

External Interface

The External Interface pushbuttons (Figure 3-7) are independent toggle on/off functions that turn editor, GPI, and peripheral bus communication on or off.

Editor Enable

When on (lit), the [EDITOR ENABLE] button turns on communication via all switcher serial ports configured as Editor ports. When [EDITOR ENABLE] is off, the switcher ignores input commands from devices connected to the serial ports.

GPI Enable

When on (lit), the [GPI ENABLE] button turns on GPI input control of the switcher. When [GPI ENABLE] is off, the switcher ignores GPI inputs from external devices but GPI outputs still function.

DPM Enable

When on (lit), the [DPM ENABLE] button turns on serial port communication with an external digital picture manipulator (DPM). When [DPM ENABLE] is off, communication with the DPM is disabled.

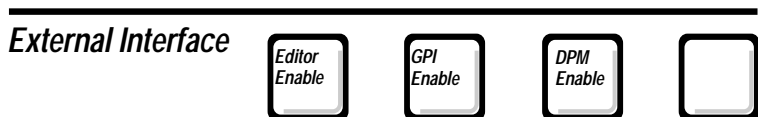

Figure 3-7. External Interface Panel Section

Fade To Black

The Fade To Black controls (Figure 3-8) allow the Program output of the switcher to be cut or faded to black and up from black. The **BLACK ON** indicator lights when black is partly or fully on. When black is fully on, all switcher levels, including the DSK, are covered up by black, and the crosspoints go to low tally.

Black Cut

Pressing the [BLACK CUT] button cuts the switcher Program output to black. Pressing it again cuts black off.

Black Mix

Pressing the [BLACK MIX] button fades the entire switcher Program output to black (or up from black if it was already faded) at the frame rate shown in the Fade To Black transition rate display.

- The button lights for the duration of the fade and remains lit as long as the output is in black.
- If you press the button a second time during a fade (up or down), the fade will reverse.

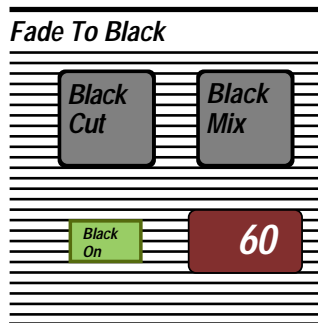

Figure 3-8. Fade To Black Panel

Keyer

The Keyer panel (Figure 3-9) delegates to control any one of the three keyers and allows you to choose the key type, key source and fill, key modifiers, and make adjustments.

Keyer Delegation Pushbuttons

The [KEY 1], [KEY 2], and [DSK] Keyer panel buttons delegate the Keyer panel to control either Keyer 1, Keyer 2, or the Downstream Keyer (DSK). Only one button may be selected at a time.

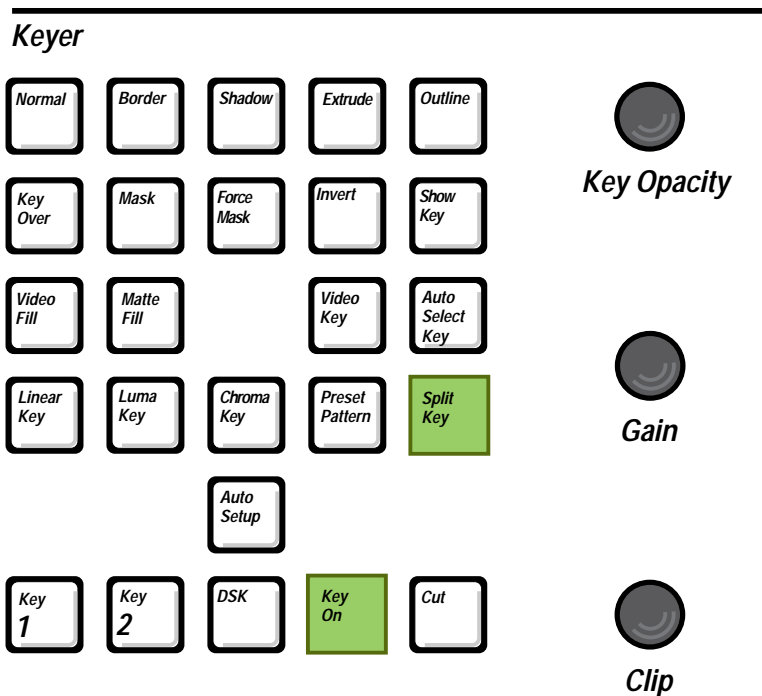

Figure 3-9. Keyer Panel

Key Source Type: Video Key and Auto Select Key

The [VIDEO KEY] and [AUTO SELECT KEY] pushbuttons select the type of key source that will cut a hole in background video to create a key effect. Only one of these buttons may be on at a time.

The [VIDEO KEY] button enables a self key in which the fill video selected on the Key bus serves as its own key source.

The [AUTO SELECT KEY] pushbutton enables automatic key source selection for the fill video that you have selected on the Key Bus. In this mode, you select the fill video crosspoint, and the source that will be used automatically is the one that was preassigned for use with that fill video in the configuration menus.

Split Key

You can do a split key (use different fill and source crosspoints) for either key source type. To split the key:

- Select a Key bus fill [CROSSPOINT].
- Turn on and hold down either the [VIDEO KEY] button or the [AUTO SELECT] button. [VIDEO KEY] uses the fill from the second Key bus crosspoint that you select as the key source. [AUTO SELECT] uses the auto select key source from the second crosspoint that you select as the key source.
- Select another Key Bus [CROSSPOINT] to serve as the key source.

The split source crosspoint lights when you select it, and lights whenever you hold down the [VIDEO KEY] or [AUTO SELECT] button. In addition, the Split Key lamp turns on to indicate a split key.

To turn off a split key, press any Key bus [CROSSPOINT], or turn off the current key source type by pressing the other source type button.

Key Fill: Video or Matte

Using the [VIDEO FILL] and [MATTE FILL] buttons you can choose to fill the key with video or matte. Only one of the two buttons can be selected at a time. In either case, the signal is supplied by selecting a Key bus crosspoint that has been designated as a video fill or a matte fill.

Key Type: Linear Key, Luma Key, Chroma Key, and Preset Pattern

For any of the switcher's three keyers you can select from among four key types: [LINEAR KEY], [LUMINANCE KEY], [CHROMA KEY] (optional), and [PRESET PATTERN]. Only one of these types can be selected at time. Double-pressing any of these buttons brings up a related display menu. For details about menus and adjustable controls relating to these four buttons, refer to the Key Modifiers section that follows and to the menu descriptions at the end of this chapter.

Linear Key

Selecting [LINEAR KEY] produces a luminance key with a gain near unity and no key edge shaping. A linear key is generally used for keying from anti-aliased characters or graphics. The fill and source are taken from the Key Bus. Adjustments and modifiers include (CLIP), (GAIN), (KEY OPACITY), [KEY MASK], [KEY INVERT], optional Borderline edge effects, and additional adjustments in the Keyer menu. If you adjust the gain away from unity, the [LUMA KEY] button lights to indicate that the key is no longer exactly linear.

Luma Key

Selecting [LUMA KEY] produces a high gain key with key edge shaping. Luminance keys are generally used when keying from video. The fill and source are taken from the Key Bus.

Adjustments and modifiers include (CLIP), (GAIN), (KEY OPACITY), [KEY MASK], [KEY INVERT], optional Borderline edge effects, and additional adjustments in the Keyer menu.

Chroma Key and Auto Setup

Choosing [CHROMA KEY] activates the optional chroma keyer and the Chroma Key menu. The chroma keyer removes a user-selected color from the Key Bus fill video, producing a key effect that consists of background video where the color used to be and fill video everywhere else. Note that the chroma keyer can be used in only one keyer at a time. If it is in use in one keyer when you select it in another keyer, the key type lamps turn off and the key layer is forced to be transparent.

When [CHROMA KEY] is on, you can select [AUTO SETUP], a feature that provides fully automatic adjustment of the chroma key.

When [AUTO SETUP] is on, a cursor appears on your Program video monitor. You may then use the joystick to position the cursor over the color you wish to key out, and press the button on the top of the joystick to select that color. The switcher automatically adjusts the chroma keyer to produce an excellent chroma key based on the color you select, and the [AUTO SETUP] button turns off, indicating that auto setup has been accomplished. To turn off [AUTO SETUP] without selecting a color, just press the [AUTO SETUP] button again.

You can also adjust the chroma keyer controls directly if you choose to. Adjustments and modifiers include (CLIP), (GAIN), (KEY OPACITY), [KEY MASK], [KEY INVERT], and a number of controls in the Chroma Keyer menu, including a dedicated chroma key box mask. (See the menu descriptions later in this section.)

Preset Pattern

The **[PRESET PATTERN]** button enables a wipe pattern to cut the key hole and assigns the Key bus to provide the fill video. Note that preset patterns and wipe transitions share the pattern generator. Changing the wipe pattern changes the preset pattern also.

When you select **[PRESET PATTERN]**, the Matte and Pattern controls delegate to preset pattern adjustment. You can use these controls to select a pattern, invert the key, set pattern position (joystick), pattern (**SIZE**), edge (**WIDTH**), edge (**SOFTNESS**), and edge softness (**SYMMETRY**). Additional adjustments are available in the Wipe menu. Using the Matte controls, you can adjust the pattern edge luminance (**LUM**), saturation (**SAT**), (**HUE**), and (**KEY OPACITY**).

Key Modifiers and Adjustments

Key modifiers and adjustments are listed and explained below. Additional modifiers and adjustments not listed here are available in the Keyer, Chroma Key, and Wipe (Preset Pattern) menus.

Key Over

The **[KEY OVER]** button, when activated, places the currently delegated effects key layer on top of the other effects key layer.

Invert

Selecting **[INVERT]** inverts the polarity of the key source. For a luminance or linear key this enables the dark areas of the source to cut the key hole rather than the light areas, which is helpful when keying from dark images on a light background.

Mask

When you select **[MASK]**, a mask created by the pattern generator inhibits the key (forces the background on) wherever you place the mask. This allows you to prevent keying in parts of the picture where you don't want it to occur.

When you select **[MASK]**, the Pattern controls delegate to control the mask. Masking occurs in the areas indicated by black on the pattern buttons, but if **[MASK/PRESET INVERT]** is on, masking occurs in the areas indicated by white on the buttons.

Note that masks and wipe transitions use the same pattern. If you change wipes, the mask pattern will change also.

Force Mask

The **[FORCE MASK]** button serves the same purpose as the Key Mask, but it uses a box mask rather than a pattern, and it is dedicated to the chroma keyer. The box mask position, size, and aspect can be adjusted via the Chroma Key Force Mask menu.

Show Key

When pressed, **[SHOW KEY]** fills the key with white for better edge visibility during setup. Pressing it a second time toggles it off.

Key Opacity

The **(OPACITY)** control sets key layer translucence. Counterclockwise increases transparency; clockwise increases opacity.

Gain and Clip

The **(GAIN)** control sets keyer response at the key edges. Setting **(GAIN)** low yields a more linear response to the key source, preserving gradual or anti-aliased key edge transitions. Setting it high increases key gain, producing sharp key edges.

The **(CLIP)** control sets the threshold of keyer response to the key source. Only those areas of the source that have a higher luminance level than the clip threshold can cut a key hole in the background and cause foreground fill video to appear. All areas of the source below the clip threshold will not cut a hole, and background video will remain visible.

In the Keyer menu, **(CLIP)** and **(GAIN)** can be assigned to operate as **(FGD CLIP)** and **(BKGD CLIP)** controls, providing independent foreground and background thresholds, which results in finer edge control (Figure 3-10). The **(CLIP)** control sets a foreground clip level so that any part of the key source with a luminance level above that threshold will cause foreground fill video to appear in the key effect. The **(GAIN)** control sets a background clip level so that any part of the key source with a luminance level below this lower threshold will cause background video to appear.

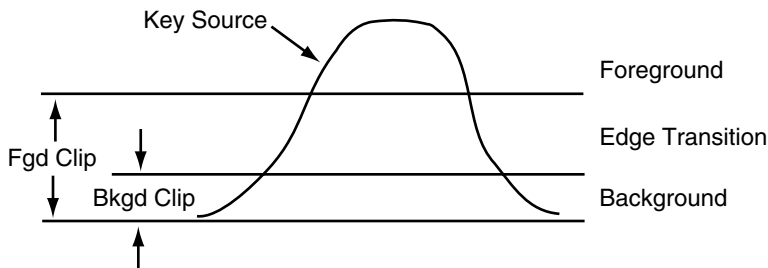

Figure 3-10. Foreground Clip/Background Clip Operation

Borderline

The Borderline[®] option adds border, drop shadow, extrusion, or outline edge effects to keys (Figure 3-11). This option can be added separately to each keyer. Control for all of the Borderline options is provided by one set of buttons that delegate with the Keyer panel:

- Four border types are available (see below). Only one border type can be selected at a time.
- To change height or width of an edge effect, hold down one of the four border mode buttons and use the (POSITIONER), which delegates automatically.
- To change the color or opacity of an edge effect, adjust the MATTE controls, which delegate automatically.

Normal

The [NORMAL] button selects a key with no edge effect.

Border

When you select [BORDER], a matte edge is placed all around the key. Width of the edge is 1–3 lines.

Shadow

When you select [SHADOW], a matte edge appears below and right or left of the key. Height is 1–6 lines and width is 1–60 lines.

Extrude

When you select [EXTRUDE], a matte edge appears that looks like a layered drop shadow, creating a block letter effect. Height of the edge is 1–6 lines and width is 1–60 lines.

Outline

When you select [OUTLINE], the area inside the key disappears, leaving only a matte edge 1–3 lines wide.

Key Memory and Key Copy Features

The key memory feature built into the control system remembers the complete keyer setup used last for each Key bus crosspoint. All you have to do is select a Key bus crosspoint, and the Keyer setup used last with it will be restored. Key Memory can be enabled or disabled in the Keyer menu.

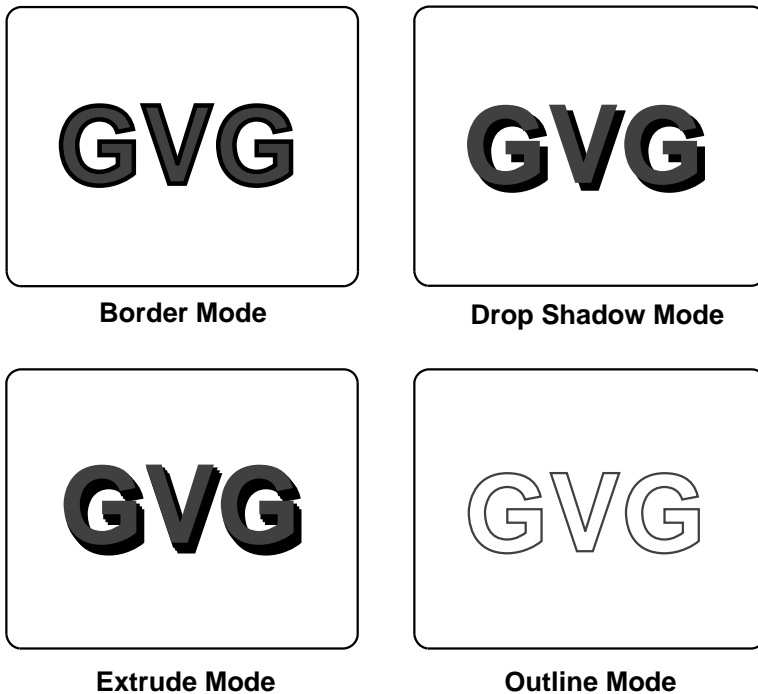

Figure 3-11. Borderline Modes

Matte

The switcher has many matte generators, including matte fill, wipe border, Borderline, and a background matte generator within each crosspoint which can be enabled in the Config/Crosspoint Map menu. The four Matte controls (Figure 3-12) can be delegated to adjust any of the available mattes.

Matte Controls

- The (HUE) knob sets the matte color.
- The (SAT) knob sets the color saturation.
- The (LUM) knob sets the color brightness.
- The (OPACITY) knob sets the translucence of the matte. At the fully clockwise setting, the matte is completely opaque.

Selections in the menu system allow you to limit the matte generators to produce only levels and colors that fall within broadcast and RGB color standards.

Matte Delegation

Delegation is automatic when you select a matte crosspoint. In addition, delegation buttons and a display are provided in the Matte panel section for manually delegating the control knobs:

- The [BKGD], [WIPE BORDER], [KEY 1], [KEY 2], and [DSK] buttons delegate the matte controls to the background generator, the wipe matte generator, or the key matte generators, respectively.
- The [FILL], [PRESET BORDER], and [BORDERLINE] buttons provide further subdelegation of the Matte knobs to the keyer's matte fill, preset pattern border matte, or Borderline matte.

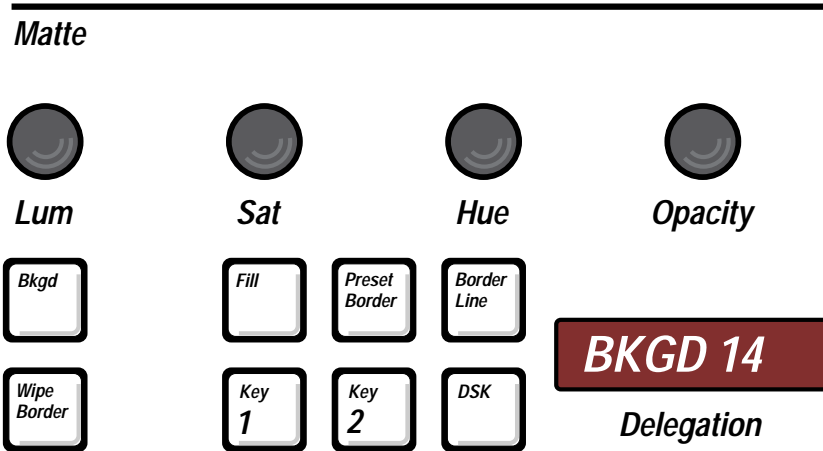

Figure 3-12. Matte Panel Section

Pattern

The Pattern panel section (Figure 3-13) allows you to select and adjust wipe patterns, preset pattern keys, and key masks.



Figure 3-13. Pattern Panel Section

Pattern Selection Buttons

The ten pattern buttons select the ten primary wipe patterns, and the [MENU] button opens the Wipe menu, providing access to more patterns.

- To select one of the ten primary patterns, momentarily press a [PATTERN] button. The button will light. Only one pattern button can be selected at a time.
- To select a menu pattern, press the [MENU] button to open the Wipe menu and use the menu controls to select a pattern from the menu.

User Wipe Buttons

You can store and recall pattern setups, including modifiers, using the four User buttons and the [LEARN USER WIPE] button.

- To store a pattern, just press [LEARN USER WIPE] followed by one of the User buttons, such as [USER 1].
- To recall a pattern, press the User button in which it is stored.
- If you need to undo a user wipe learn or recall, press [UNDO] after the learn or recall before you press any other button. The conditions prior to the learn or recall will be restored.

Pattern Adjustments

Available pattern adjustment controls are described below.

Positioner (Joystick)

The positioner controls operate as follows:

- Turning on the [POS] button enables the positioner and returns the pattern to the position it was last moved to. You can then use the positioner to move the pattern to any screen position. Turning off the [POS] button disables the positioner.
- When you press the [CENTER] button, the pattern returns to its default center position.

Wipe Direction

The three wipe direction buttons are [NORMAL], [REVERSE], and [FLIP FLOP]. Normal and Reverse modes cannot both be selected at the same time. However, Flip Flop mode works in combination with either Normal or Reverse.

- When [NORMAL] is on, the white areas on the pattern buttons indicate new video that will be revealed as the pattern moves.
- When [REVERSE] is on, the black areas on the pattern buttons indicate new video.
- When [FLIP FLOP] is on together with one of the other buttons (Normal or Reverse), the first wipe transition moves in the direction indicated by the other lighted button. Then the next transition moves in the opposite direction (flip flop). This feature allows you to “wipe on” and “wipe off” using whichever starting direction you choose.

Mask Preset Pattern/Wipe

The [MASK/PRESET PATTERN] and [WIPE] buttons delegate the (WIDTH), (SOFTNESS), (SYMMETRY), and [MASK/PRESET INVERT] controls to a mask or preset pattern key or to a wipe pattern. Only one of the two buttons may be on at a time.

Size and Border Width, Softness, and Symmetry

- Patterns can have a matte-filled border if you turn on the [BORDER] pushbutton. When [BORDER] is on, the (WIDTH) knob sets the width of the border. The Matte controls set the edge color.
- When you turn on the [SOFT] button, the (SOFTNESS) knob sets the diffusion of the pattern edge. When the [SOFT] button is off, the pattern has a hard edge.
- If the [SYMM] and [SOFT] buttons are both on, the (SYMMETRY) knob sets the balance or evenness of the softness applied to the pattern edge. When the [SYMM] button is off, softness of the edge is evenly balanced. When the [SOFT] button is off, the symmetry control has no effect.

Mask/Preset Invert

When you select a mask or preset pattern, you can toggle the [MASK/PRESET INVERT] button to change the area of the picture that is affected by the mask or fill video. When the invert function is off, the white area on the pattern buttons represents the area of the screen where masking occurs or where the fill video appears. When the invert function is on, the black area on the pattern buttons represents the area of the screen where masking occurs or where the fill video appears.

Wipe Menu

When you press the [MENU] button, the Wipe menu appears in the menu display. This menu provides access to additional wipe patterns as well as additional pattern modifiers, including aspect ratio adjustments, sine wave modulation of the pattern, pattern rotation, and pattern multiplication.

Transition

The Transition section (Figure 3-14) allows you to select and transition the effects background and key layers (but not the DSK) on or off air at the Program output. You can do a cut transition or you can use an automatic transition or the lever arm to do a mix or wipe transition.

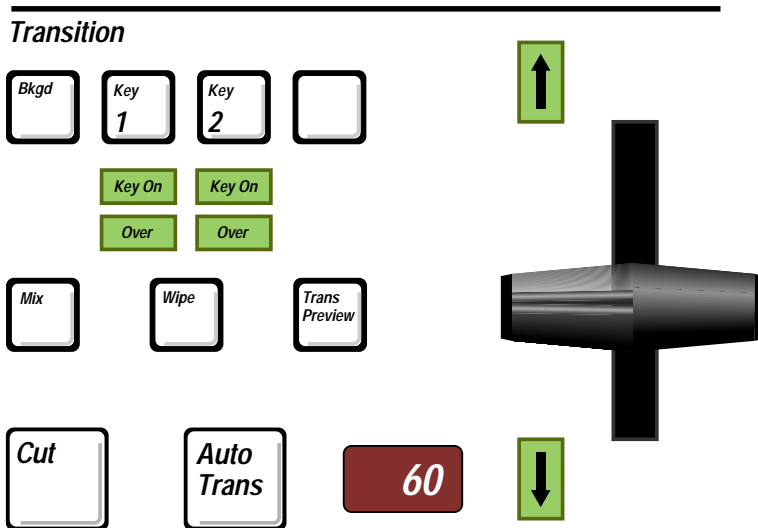

Figure 3-14. Transition Controls

Bkgd, Key 1, Key 2

The [BKGD], [KEY 1], and [KEY 2] pushbuttons delegate the transition controls to the effects keyers and/or the PGM/PST background mixer. You can select one button or push multiple buttons simultaneously. The selected buttons light and the others turn off automatically. The next transition affects only the lit functions.

Bkgd

The [BKGD] button selects the background transition mode and delegates the transition controls to the PGM/PST background mixer. The next transition places PST bus video on air and takes the current PGM bus video off air. Selections on the two buses flip-flop at the end of the transition.

Key 1 and Key 2

The [KEY 1] and [KEY 2] buttons select the key transition mode and delegate the Key bus, Keyer, Matte, and Transition controls to Keyer 1 or Keyer 2, respectively. When you select one of these buttons, the next effects transition takes the selected key on or off air at the Program output. If you select both buttons, the Key bus and Keyer delegate to Keyer 1, but both keys are affected by the next transition.

- The KEY ON legend lights when the keyer is on air.
- The OVER legend lights to indicate which key layer is on top of the other.
- If you double-press [KEY 1] or [KEY 2], the Keyer menu appears, allowing you to make adjustments to the key.

Mix and Wipe Transition Type

The [MIX] and [WIPE] buttons determine the appearance of the next effects automatic or lever arm transition—either a dissolve or a pattern transition. Only one button may be selected at a time.

Mix

The [MIX] button selects a dissolve transition. Keys dissolve on or off, and/or Preset video dissolves into and replaces Program video.

Wipe

The [WIPE] button selects wipe transition mode and delegates the Pattern and Matte sections to wipe adjustments. In wipe transition mode, a moving pattern edge wipes keys on or off and/or replaces Program bus video with Preset bus video.

- The Pattern controls allow you to select a wipe pattern and position its starting point. They also allow you to turn the wipe border on or off, adjust edge or border softness, and adjust edge or border softness symmetry.
- The Matte controls allow adjustment of the wipe border characteristics, including luminance, saturation, hue, and opacity.
- A double press of the [WIPE] Transition button brings up the Wipe menu, giving you access to more pattern adjustments, including more patterns, aspect, reverse, rotation, and multiplication.

Transition Controls: Cut, Auto Trans, and Lever Arm

The transition controls give you three ways to do an effects key or PGM/PST transition: an instantaneous cut, an automatic transition of a preset duration, or a manual lever arm transition.

- The [CUT] button causes a full transition to occur instantly. The button does not light.
- The [AUTO TRANS] button starts an immediate transition that extends for the period of time (in video frames) shown in the Transition rate display. The button lights for the duration of the transition. To set a new transition rate, press [M/E TRANS] in the E-MEM section, enter a number using the keypad, and press [ENTER]. The new rate appears in the Transition rate display.

Pause feature: An automatic transition in progress pauses if you press [AUTO TRANS] again and resumes if you press it a third time.

- The LEVER ARM gives you direct manual control of the direction and speed of a transition. When you move the lever arm off of a limit, the transition begins and exactly tracks the lever arm motion. A green arrow lights and points in the direction the lever must travel in order to finish the transition.

You can also use the three transition methods together:

- If you press [CUT] during an auto transition or when the lever arm is partly off the limit, the sources involved will instantly swap places; that is, the source that was transitioning on will go off and vice versa.
- You can begin a transition with the lever arm and finish with [AUTO TRANS], or you can begin an automatic transition and finish with the lever arm.

Visual Display and Menus

The visual display in the upper left corner of the control panel presents system menus, and the associated pushbuttons and knobs provide control over menu functions. Figure 3-15 shows the display together with its pushbuttons and knobs.

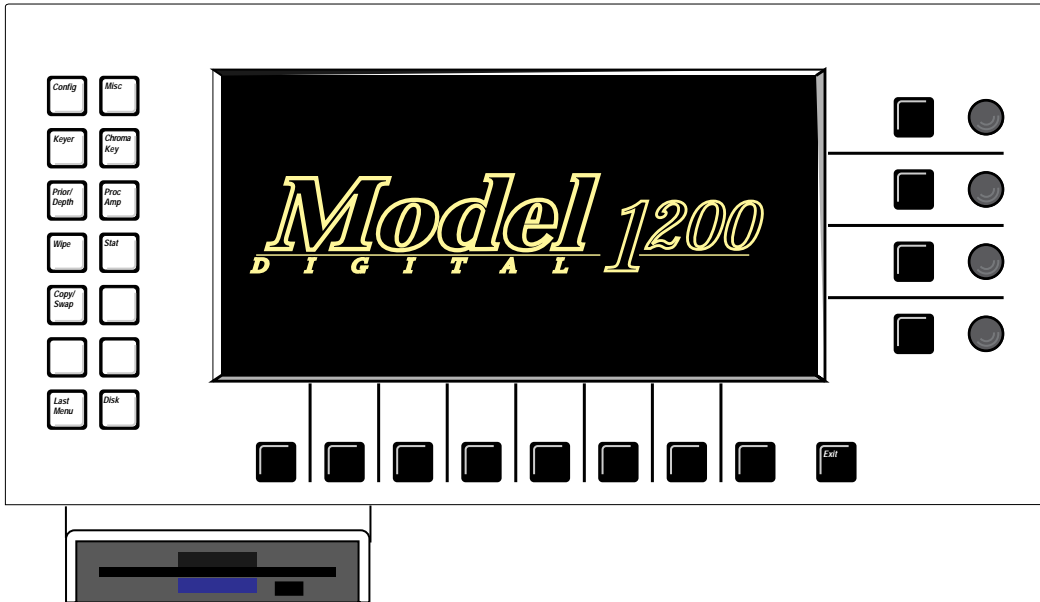

Figure 3-15. Visual Display Panel Section

Menu Pushbuttons and Knobs

The display panel includes associated pushbuttons and knobs that work interactively with the display menus to control the switcher operation. General operation of these menu buttons and knobs is explained below:

- The white menu “hot buttons” at the left of the display activate the top level menus.
- The black buttons and knobs surrounding the display are “soft” buttons and knobs that change function with each menu. Labels displayed along the bottom and right edges of each menu indicate the functions of the soft controls. The “>” display symbol indicates a lower level menu that you can view when you press the associated soft button.
- **All menus** - Quickly pressing a soft knob’s soft button twice will return the value to default.
- The **[Exit]** button takes you up one menu level.

Keypad Numeric Entry

The buttons associated with the soft knobs at the right of the menu display enable keypad entry of soft knob values using the ten register buttons on the E-MEM panel. This is helpful when multiple digit numbers need to be entered.

To enter a value, press the associated soft button to highlight the value field on the menu, enter a number using the E-MEM keypad, and press **[ENTER]** on the E-MEM panel. To enter a negative number, first press the number on the E-MEM keypad, then the +/- button below the E-MEM keypad.

Double-Press Pushbuttons

Many of the pushbuttons on the switcher panel will automatically bring up the appropriate menu if you double press them (press the button twice in rapid succession). Pushbuttons that have corresponding double-press functions (called DPOPs, for “double press opens”) are listed in Table 3-1.

Table 3-1. Double-Press Pushbuttons

DPOPs	Action
<ul style="list-style-type: none">• Crosspoints• Bus Delegates Aux 1 and Aux 2• Effects Send Key 1, Key 2, DSK	Opens Proc Amp Menu
<ul style="list-style-type: none">• Keyer buttons	Opens Keyer Menu
<ul style="list-style-type: none">• Chroma Key button	Opens Chroma Key Menu
<ul style="list-style-type: none">• Clear Button (E-MEM subpanel)	Opens Misc Menu
<ul style="list-style-type: none">• Soft Buttons on right side of menu	Restores soft knob to default value

Menus

The main menus corresponding to the white top level menu buttons at the left of the display are presented in alphabetical order on the following pages. Each main menu and its sub-menus are described in detail. The main menus are the following:

- Chroma Key—page 3-42
- Configuration—page 3-54
- Copy/Swap—page 3-75
- Disk—page 3-80
- Keyer—page 3-98
- Last Menu—page 3-102
- Miscellaneous—page 3-102
- Priority/Depth—page 3-104
- Proc Amp—page 3-106
- Status—page 3-108
- Wipe—page 3-110

See the following page for a menu tree that presents all of the main menus and their sub-menus.

Menu Tree

Figure 3-16 presents a chart of the 1200 menu system. The menus shown on the left side of the figure are the top-level menus that you can access by pressing the white pushbuttons on the left side of the display. Additional lower level menus are shown branching to the right in the figure.

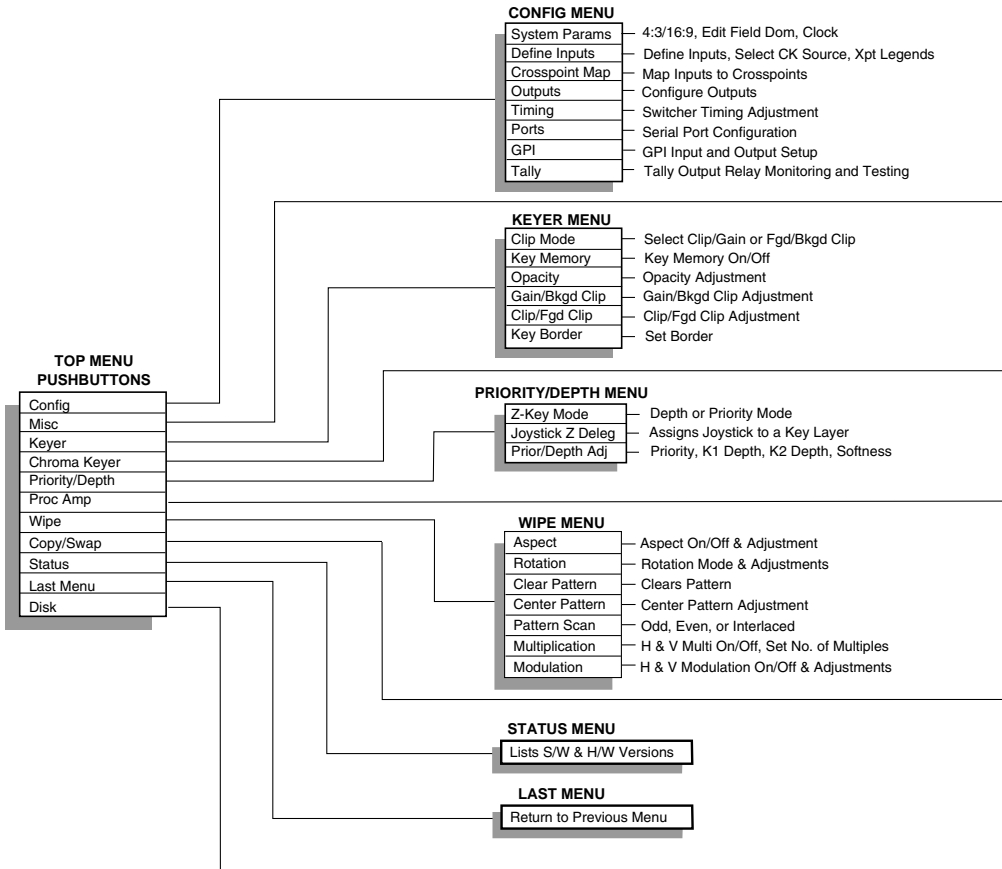

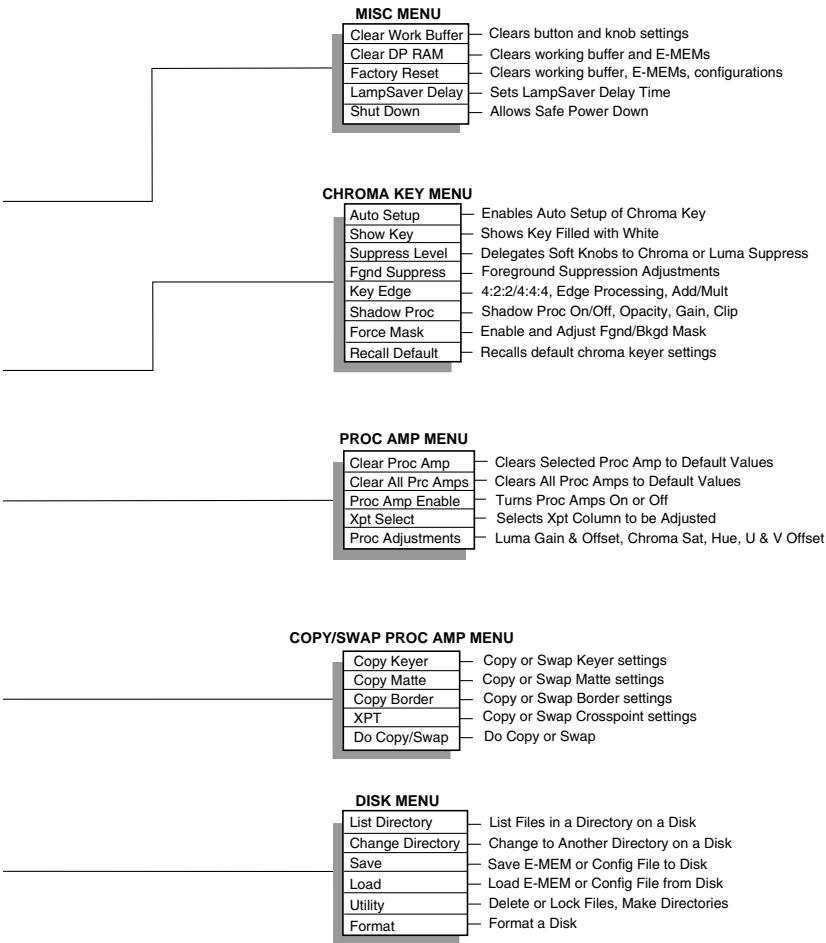

Figure 3-16. Display Menu Tree

Chroma Key Menus

Press the **[Chroma Key]** top menu button to display the Chroma Key top-level menu shown in Figure 3-17. This menu provides control of chroma keys for any of the switcher's three keys.

Chroma Key Menu Functions:

[AUTO SETUP]—Turns on chroma key Auto Setup mode. This mode automatically creates a chroma key when you select the chroma key background color. To select this color, position the monitor cursor over the desired color in the background scene and press the button on the top of the joystick.

[SHOW KEY]—Enables or disables Show Key mode. When on, this mode fills the chroma key foreground with a white matte over a black matte background. This makes edges and foreground transparency more visible for fine adjustment.

[SUPPRESS LEVEL]—Selects background chroma or luma for suppression level adjustment.

(BACKGROUND LUMA SUPPRESS LEVEL)—Adjusts the level of luminance suppression applied to the chroma key background scene.

(BACKGROUND CHROMA SUPPRESS LEVEL)—Adjusts the level of chroma suppression applied to the chroma key background scene. Chroma suppression cancels out unwanted color in the background. Normally this control should be set at about 50%.

[FGND SUPPR>]—Displays the Foreground Suppress menu.

[KEY EDGE>]—Displays the Key Edge menu.

[SHADOW PROC>]—Displays the Shadow Proc menu.

[FORCE MASK>]—Displays the Force Mask menu.

[RECALL DEFAULT>]—Restores the chroma keyer to its default settings.

(BACKGROUND HUE ANGLE)—Selects the color in the chroma key background scene that will be suppressed by the background suppression feature.

(SELECTIVITY)—Narrows or widens the range of hues captured by the chroma key hue adjustment.

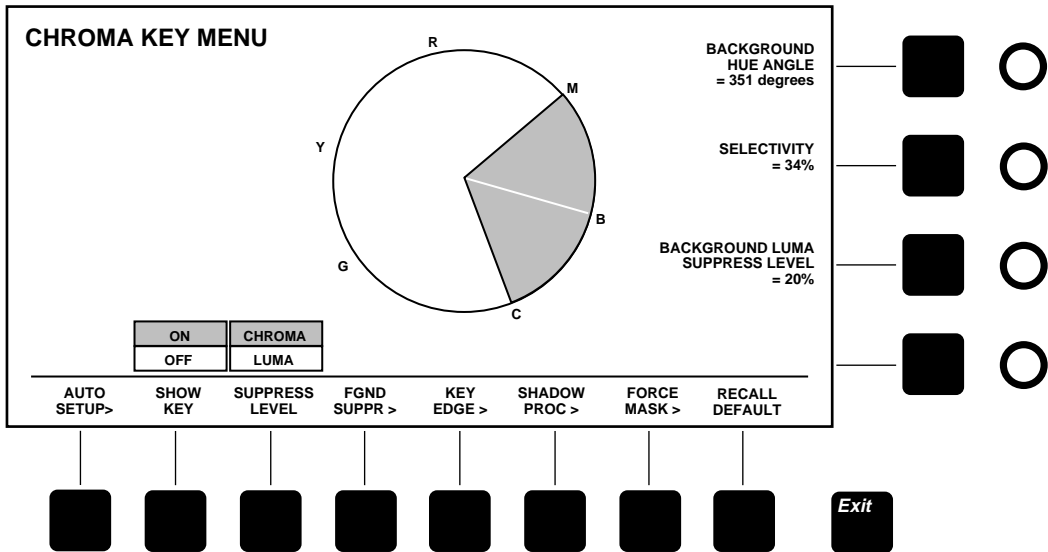

Figure 3-17. Chroma Key Top Menu

Chroma Key Auto Setup Menu

From the Chroma Key top menu, press **[AUTO SETUP]** to display the Chroma Key Auto Setup menu shown in Figure 3-18.

Auto Setup Menu Functions:

[TAKE]—Selects the desired chroma key background color when the Auto Setup cursor on the Program monitor has been placed over the desired color using the joystick. The **[TAKE]** button serves the same function as the button on the top of the joystick when Auto Setup mode is on.

[CANCEL]—Cancels Auto Setup mode.

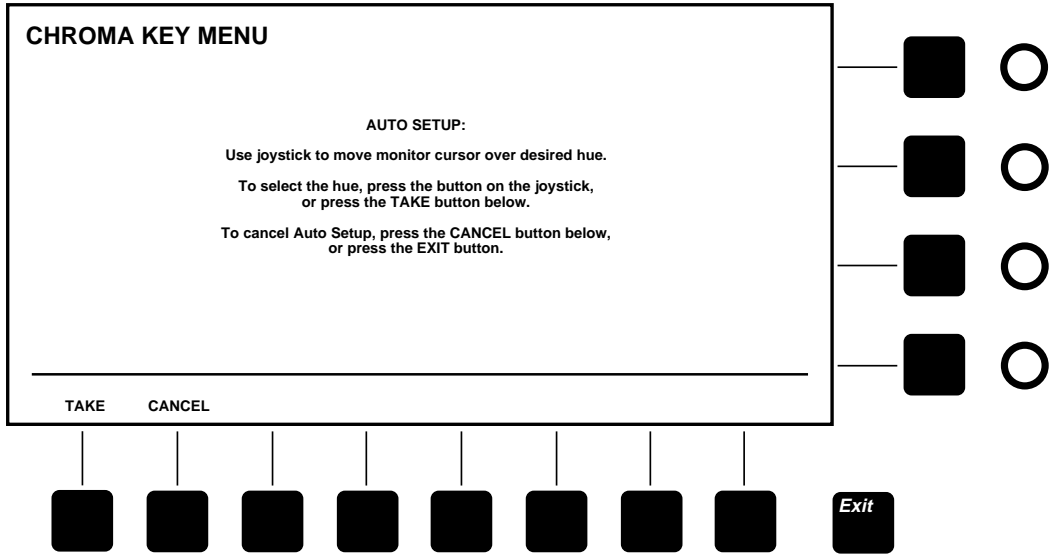

Figure 3-18. Chroma Key Auto Setup Menu

Chroma Key Fgd Suppress Menu

From the Chroma Key top menu, press **[FGD SUPPRESS>]** to display the Chroma Key Foreground Suppress menu shown in Figure 3-19. This menu includes adjustments to suppress (remove) background color and noise that appears in the foreground.

Foreground Suppress Menu Functions:

[FG NOISE SUPPRESS]—Sets the level of foreground noise suppression to off, low, medium, or high. This removes noise from the low chroma portions of the foreground video.

[FG COLOR SUPPRESS]—Turns foreground color suppression **ON** or **OFF**. When **ON**, foreground suppression removes background color that spills onto the foreground video. This unwanted color may be the same as the background color (typically, blue or green), or it may mix with a foreground color. For example, blue spill may mix with red in the foreground, distorting the red to magenta. Foreground color suppression allows you to suppress this distortion, restoring the original foreground color.

[HUE ANGLE]—Delegates foreground suppression color detection soft knobs as explained below. Two separate colors can be independently detected and suppressed.

(FOREGROUND HUE SELECT ANGLE)—This soft knob appears when **[HUE ANGLE]** is set to **SELECT**. It selects the hue in the foreground that will be removed by the suppression circuitry. This is useful for removing background color that spills onto the foreground.

(SELECTIVITY)—Narrows or widens the range of hues selected by the Foreground Hue Angle adjustments.

(FOREGROUND HUE SUPPRESS ANGLE)—This soft knob appears when **[HUE ANGLE]** is set to **SUPPRESS**. When you adjust this soft knob, you are selecting a second color to be suppressed in the foreground. This is useful for removing variations of the background color that occur when the background color mixes with foreground colors.

[SUPPRESS LEVEL]—Selects foreground chroma or luminance suppression level adjustment.

(FOREGROUND LUMA SUPPRESS LEVEL)—Appears when **[SUPPRESS LEVEL]** is set to **LUMA**. Adjusts the level of luminance suppression applied to the foreground video.

(FOREGROUND CHROMA SUPPRESS LEVEL)—Appears when **[SUPPRESS LEVEL]** is set to **CHROMA**. Adjusts the level of chroma suppression applied to the foreground video. Normally this control should be set at about 100%.

(FRINGE CONTROL)—Controls the color of the foreground video in the fringe areas. Sometimes the fringe area is affected by the background color in such a way that the color in the fringe area is lost. The Fringe control allows you to add color back into the fringe area.

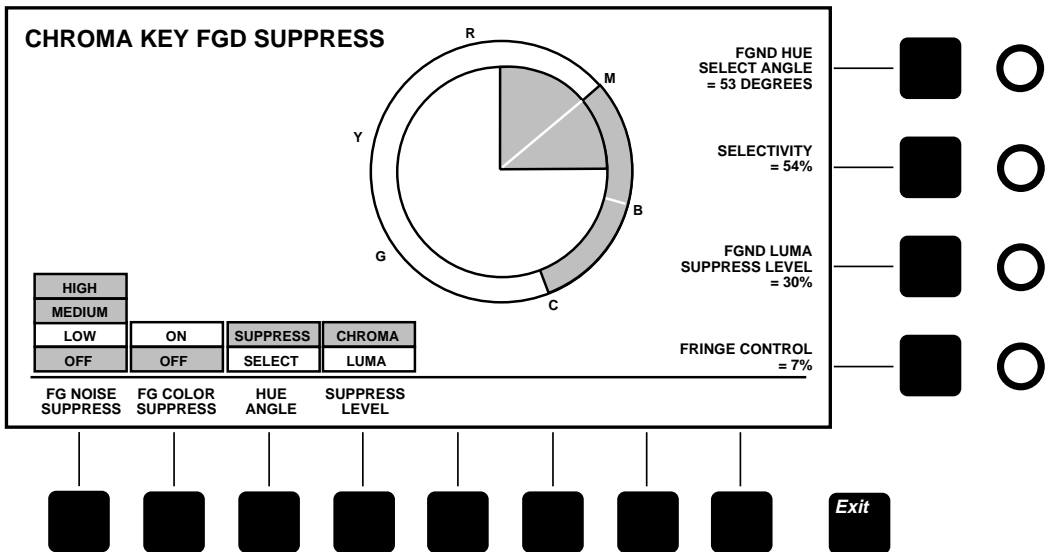

Figure 3-19. Chroma Key Foreground Suppress Menu

Chroma Key Edge Menu

From the Chroma Key top menu, press **[KEY EDGE>]** to display the Chroma Key Edge menu shown in Figure 3-20.

Chroma Key Edge Menu Functions:

[KEY SOURCE]—Selects a 4:2:2 resolution chroma key signal from the KEY bus or a 4:4:4 dual link source, such as a telecine output.

[V EDGE PROC]—When **ON**, this feature enables vertical processing of the chroma key and adds a frame of delay to the chroma key path. This allows you to adjust the size of the key along the top and bottom edges. The **TEMPORAL** selection averages two frames together to reduce noise in the edge. When **OFF**, all vertical edge processing is turned off, including the frame of delay. Note that the frame of delay may cause problems for some applications, such as recording on a VTR in write-after-read mode; turn edge processing **OFF** to turn off the delay.

[KEY SIZE]—Enables adjustment of horizontal and/or vertical key size using the **(KEY SIZE)** soft knob. **[V EDGE PROC]** must also be **ON** to allow vertical key sizing. When **OFF**, key size is unity.

(KEY SIZE)—Adjusts size of the key in the horizontal and/or vertical dimension when enabled by the **[KEY SIZE]** button.

[KEY SOFTNESS]—Enables softness adjustment of the horizontal and vertical key edges. When **OFF**, H and V softness are zero.

(KEY SOFTNESS)—Adjusts horizontal or vertical key edge softness when enabled by the **[KEY SOFTNESS]** button.

[KEY POSITION]—Enables adjustment of the key position.

(KEY POSITION)—Adjusts horizontal or vertical key position when enabled by the **[KEY POSITION]** button.

[EDGE CONTROL]—Selects a multiplicative or additive (matte-style) chroma key. Multiplicative works best when the key edges are soft, such as when smoke or fog is present in the foreground. Additive works best when you are striving to preserve as much realistic detail in the key edges as possible.

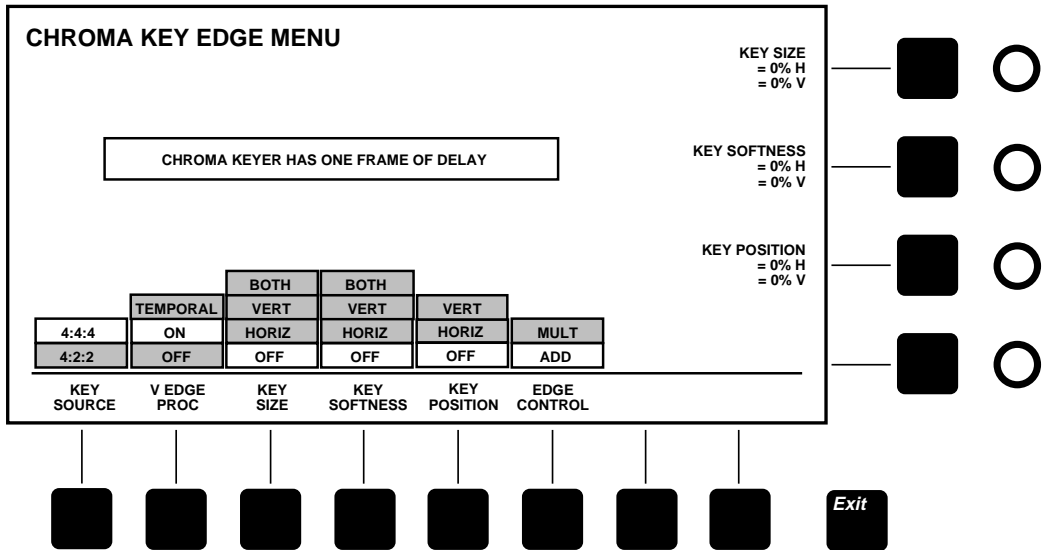

Figure 3-20. Chroma Key Edge Menu

Chroma Key Shadow Proc Menu

From the Chroma Key top menu, press *[SHADOW PROC>]* to display the Chroma Key Shadow Proc menu shown in Figure 3-21. This menu allows you to adjust chroma key shadows.

Shadow Proc Menu Functions:

[SHADOW PROC]—Turns shadow processing *ON* or *OFF*. When shadow processing is on, the following shadow adjustments are available:

(SHADOW CLIP)—Sets the threshold level above which the shadow image becomes visible.

(SHADOW GAIN)—Sets shadow density.

(SHADOW OPACITY)—Interacts with the Shadow Gain control to remove noise from the shadow and adjust shadow density.

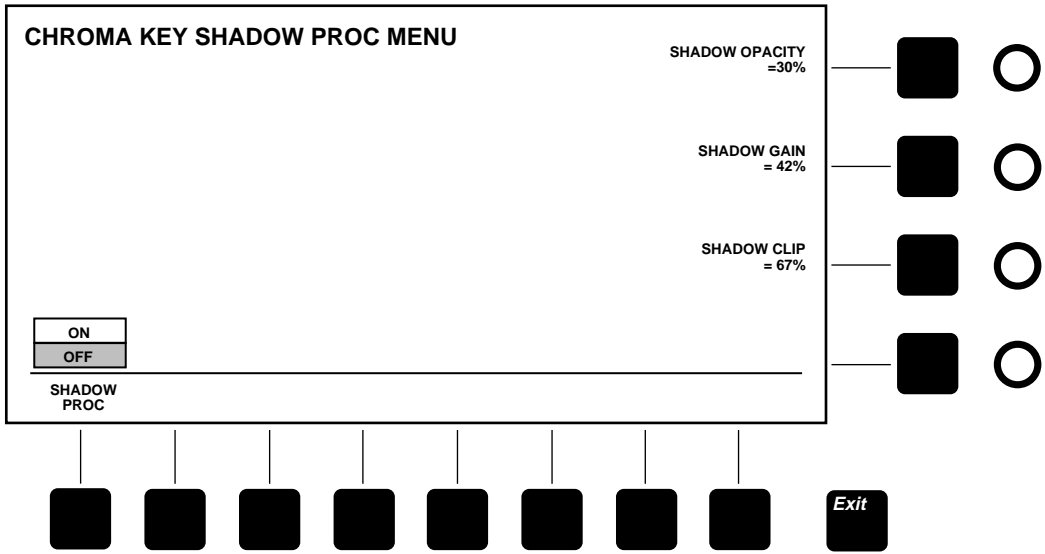

Figure 3-21. Chroma Key Shadow Proc Menu

Chroma Key Force Mask Menu

From the Chroma Key top menu, press **[FORCE MASK>]** to display the Chroma Key Force Mask menu shown in Figure 3-22. This menu controls the chroma key box mask, allowing you to apply it to the background or foreground suppression to turn off the key in selected areas.

Force Mask Menu Functions:

[BKGD MASK]—Turns background suppression mask *ON* or *OFF*. When *ON*, the mask forces the key off, preventing keying in the masked areas. For example, if a person in the chroma key scene has blue eyes (assuming a blue keying color), his or her eyes will need to be masked to prevent them from keying.

[FGND MASK]—Turns foreground suppression mask *ON* or *OFF*. When *ON*, this function prevents foreground suppression in the masked areas of the foreground. For example, a foreground object may be the same color as the color you are trying to suppress in another part of the foreground. You can prevent suppression of the object using the mask.

[INVERT MASK]—Inverts the mask. Normally, the area inside the mask box is masked. When invert is *ON*, the area outside the mask box is masked.

[JOYSTICK]—Turns joystick positioning of the mask *ON* or *OFF*.

(SIZE)—Adjusts size of the mask shape.

(ASPECT)—Adjusts aspect ratio of the mask box.

(SOFTNESS)—Adjusts softness of the mask edges.

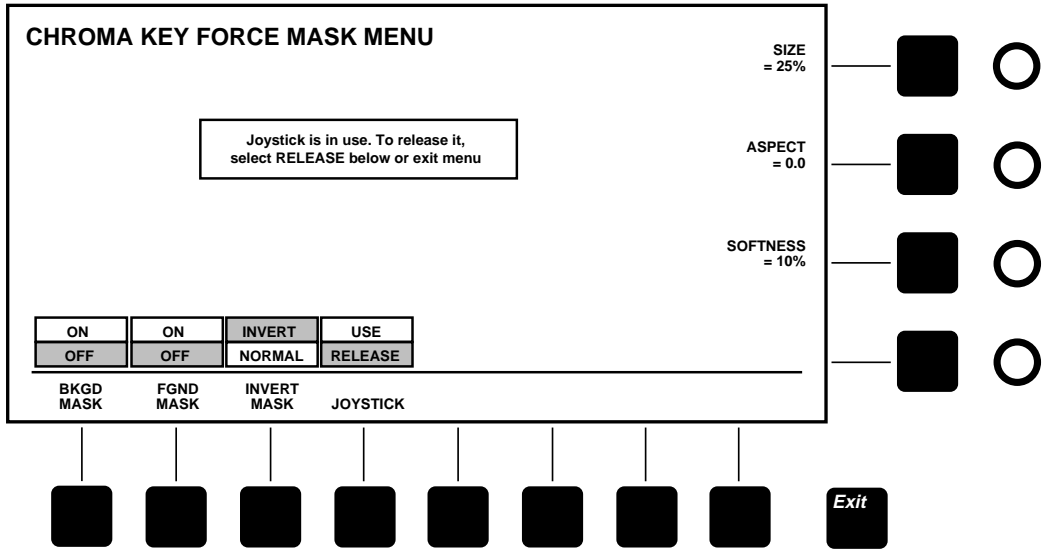

Figure 3-22. Chroma Key Force Mask Menu

Configuration Menus

Press the white **[Config]** top menu button to display the Configuration top menu shown in Figure 3-23. This menu lets you configure your system to suit your particular requirements.

Configuration Menu Functions:

[SYSTEM PARAMS>]—Displays the System Parameters menu.

[DEFINE INPUTS>]—Displays the Define Inputs menu.

[XPT MAP>]—Displays the Crosspoint Map menu.

[OUTPUTS>]—Displays the Outputs menu.

[TIMING>]—Displays the Timing menu.

[PORTS>]—Displays the Port Configuration menu.

[GPI>]—Displays the GPI Inputs menu.

[TALLY>]—Displays the Tally menu.

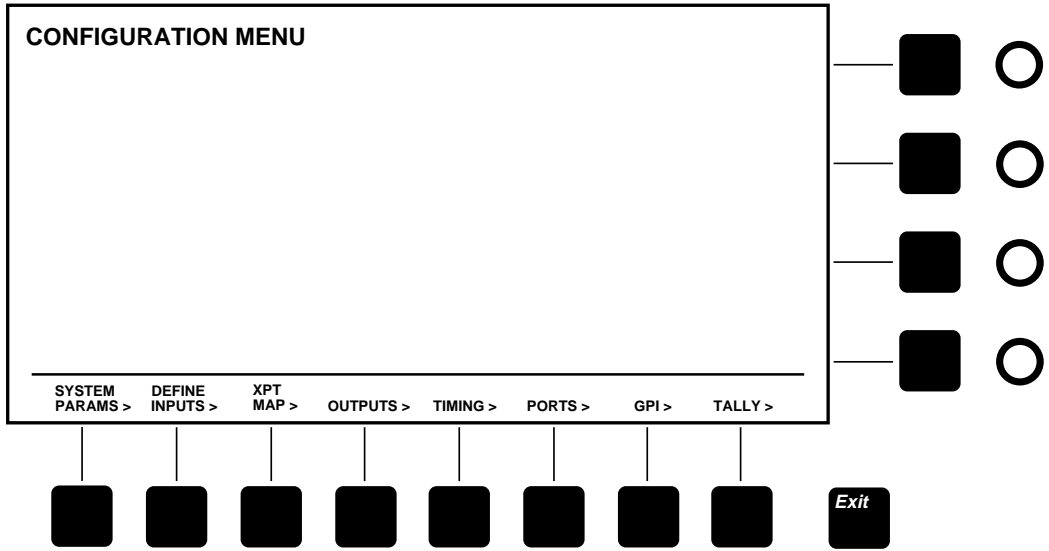

Figure 3-23. Configuration Top Menu

System Parameters Menu

From the Configuration top menu, press *[SYSTEM PARAMS>]* to display the System Parameters menu shown in Figure 3-24.

System Parameters Menu Functions:

[VIDEO ASPECT]—Sets switcher to operate in 4:3 or 16:9 aspect.

[EDITOR FLD DOM]—Sets field dominance to none, odd, or even. This ensures consistent switching on the desired field.

[SELECT DATE/TIME]—Enables setting of date or time using soft knobs.

[CONFIRM DATE/TIME]—Confirms clock setting.

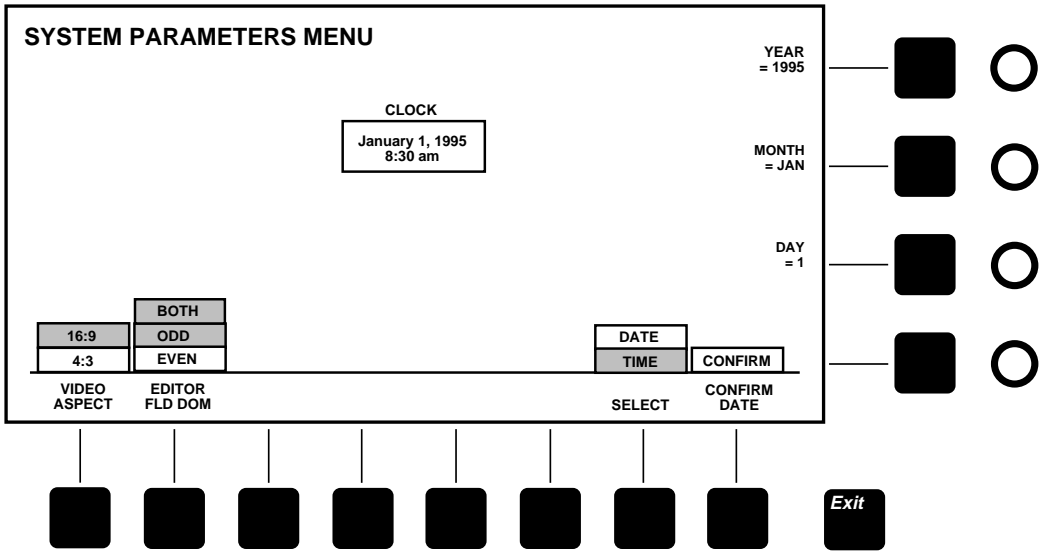

Figure 3-24. System Parameters Menu

Define Inputs Menu

From the Configuration menu, press **[DEFINE INPUTS>]** to display the Define Inputs menu shown in Figure 3-25.

Define Inputs Menu Functions:

[PHYSICAL INPUT]—Selects and highlights the input to be defined.

[AUTO SEL KEY SOURCE]—Assigns another input to serve as the automatically selected key source for the currently displayed input. Turn the knob to set the auto select source for the highlighted input.

[CLEAR NAME]—Erases the name of the currently selected input.

[ENTER NAME]—Enables entering of a name for the currently selected input using a keyboard attached to the back of the panel, or a special dial and button entry screen.

[ENTRY MODE]—Toggles between keyboard entry for “name,” or a special dial and button entry screen.

[BITS]—Sets the selected input to 8 or 10 bits to match the resolution of the signal source.

[TYPE SELECT]—Identifies the type of signal connected to the selected input. Choices are depth signal, key signal, shaped video (shaped by a key signal), or normal video.

[EFX RTN FLAG]—Identifies the selected input as a return input for Effects Send video or key coming from a digital effects system. To set the flag, highlight the input and press the **[EFX RTN FLAG]** soft button.

[4:4:4 CK SOURCES>]—Displays the 4:4:4 Chroma Key Sources menu.

[XPT DISP LEGENDS]—Displays the XPT Display Legends menu.

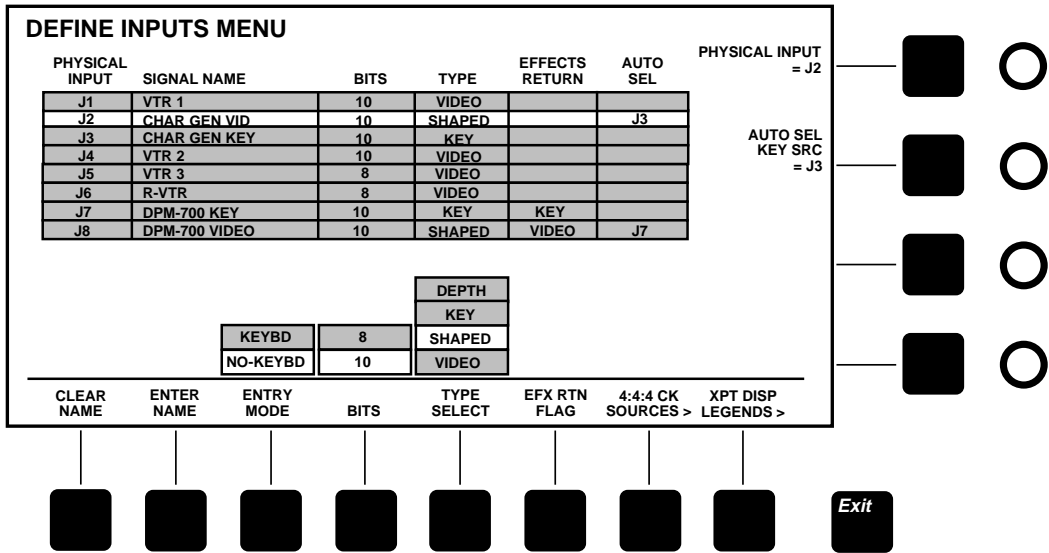

Figure 3-25. Define Inputs Menu

Configuration Name Inputs Menus

These menus allow you to input signal and local names without using a separate keyboard. The Signal Name (Figure 3-26) and Local Name (Figure 3-27) menus are found under the [Config] top-level menu. From the Configuration Menu screen the submenu path is:

- **Signal Name Menu**—Press [DEFINE INPUTS>] then [ENTER NAME] to access the menu
- **Local Name Menu**—Press [DEFINE INPUTS>] then [XPT DISP LEGENDS>] then [ENTER LOCAL] to access the menu

NOTE: You may also use an external keyboard to enter these characters if so desired. But note that these menus will not appear if a keyboard is attached to the control panel.

1. Select each character by turning the soft knobs located to the right of the menu display.
2. Enter the selected character by pressing the [ACCEPT CHAR] soft button. The new character will be displayed in the menu.
3. Continue selecting characters in this manner until the name is spelled out in the menu.
4. Press [ACCEPT NAME] to store the name. The system automatically returns to the previous menu.

NOTE: The Signal Name menu will accept up to fifteen characters. The Local Name menu will accept up to four characters. The Readout Display Option board must be present to show the four character Local Names that have been assigned.

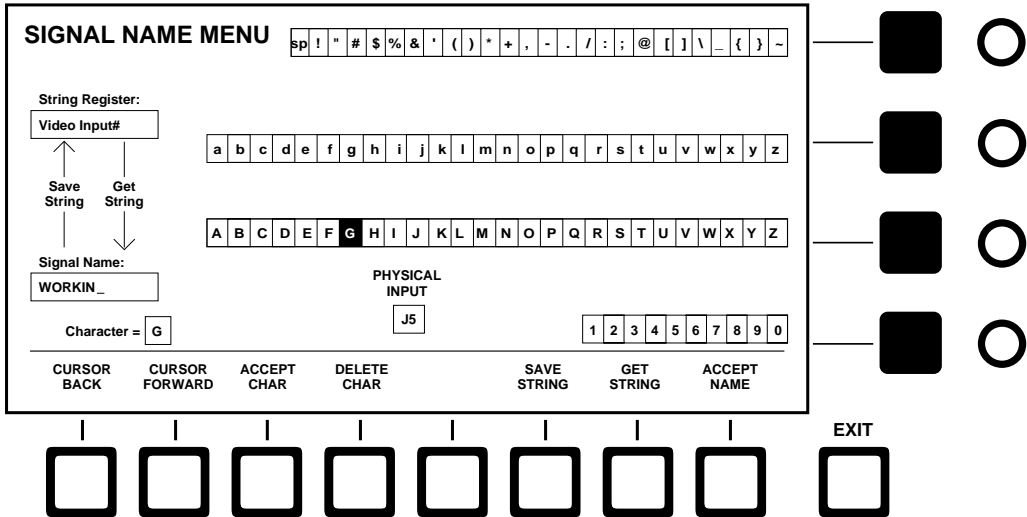

Figure 3-26. Signal Name Menu

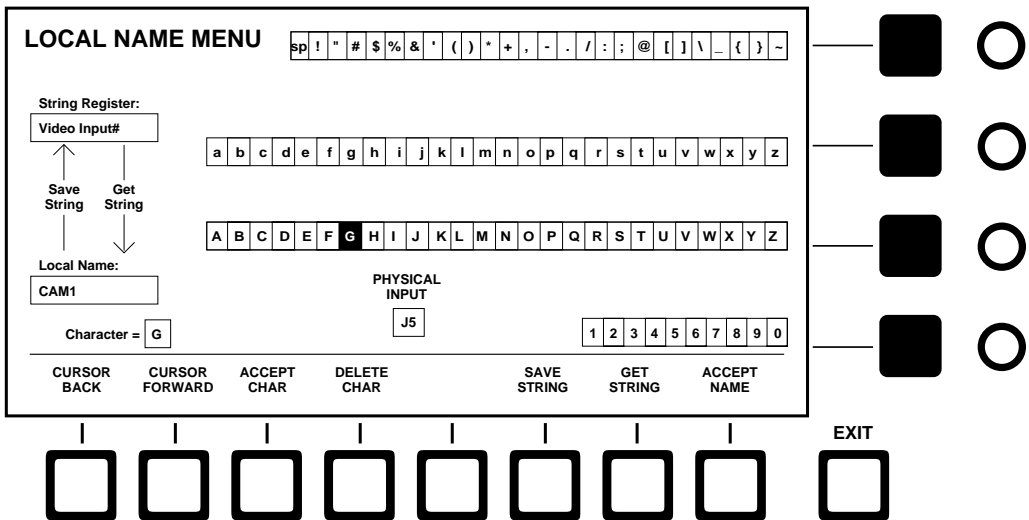

Figure 3-27. Local Name Menu

4:4:4 Chroma Key Sources Menu

From the Configuration /Inputs/Define Inputs menu, press **[4:4:4 CK SOURCES>]** to display the 4:4:4 CK Sources menu shown in Figure 3-28. The soft knobs in this menu map 4:4:4 chroma key channels A and B to physical BNC inputs on the back of the frame.

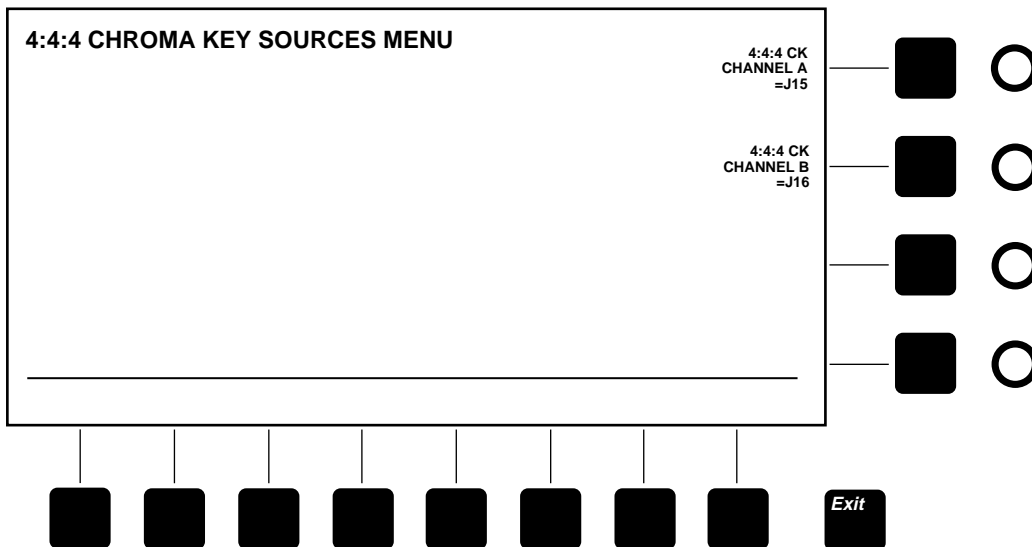

Figure 3-28. 4:4:4 Chroma Key Sources Menu

Crosspoint Display Legends Menu

From the Configuration /Inputs/Define Inputs menu, press **[XPT DISP LEGENDS>]** to display the Crosspoint Display Legends menu shown in Figure 3-29. This menu permits you to set the names that appear in the LED displays above the crosspoint buttons.

Crosspoint Display Legends Menu Functions:

(PHYSICAL INPUT)—Scrolls through the physical inputs in the display table, highlighting the current selection.

[CLEAR LOCAL]—Erases the local name for the highlighted physical input.

[ENTER LOCAL]—Allows you to enter a new local name for the highlighted physical input using a keyboard connected to the back of the panel.

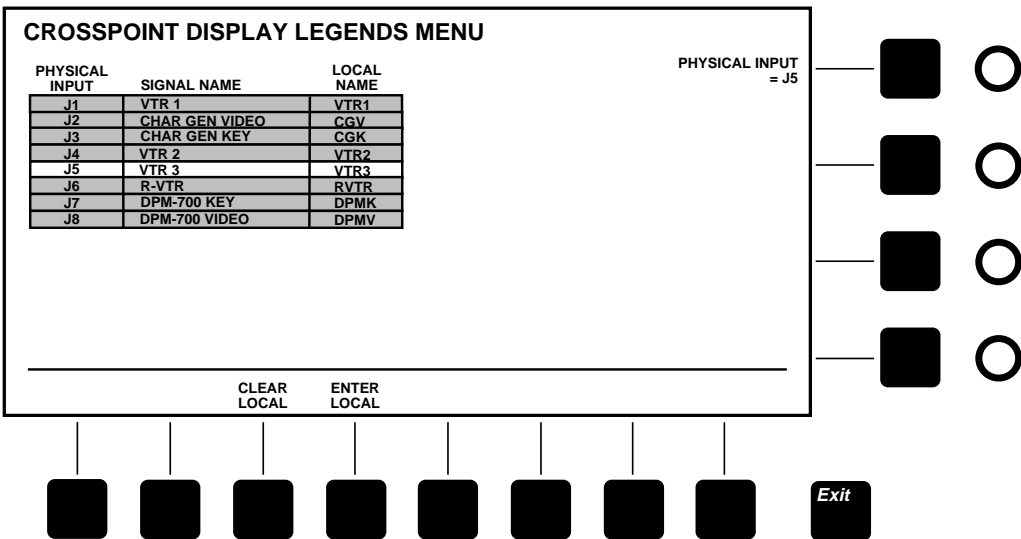

Figure 3-29. Crosspoint Display Legends Menu

Crosspoint Map Menu

From the Configuration top menu, press *[XPT MAP>]* to display the Crosspoint Map menu shown in Figure 3-30. This menu permits mapping of input BNC connectors to crosspoint pushbutton columns.

Crosspoint Map Menu Functions:

(XPT)—Selects a crosspoint number in the display table.

(PHYSICAL INPUT)—Selects and assigns a physical BNC input to the crosspoint currently highlighted in the display table.

[XPT MAP SELECT]—Selects between two crosspoint maps, the *NORMAL* map and the *ALTERNATE* map. This feature is useful if you have two different uses for the switcher and you want to set up two different maps.

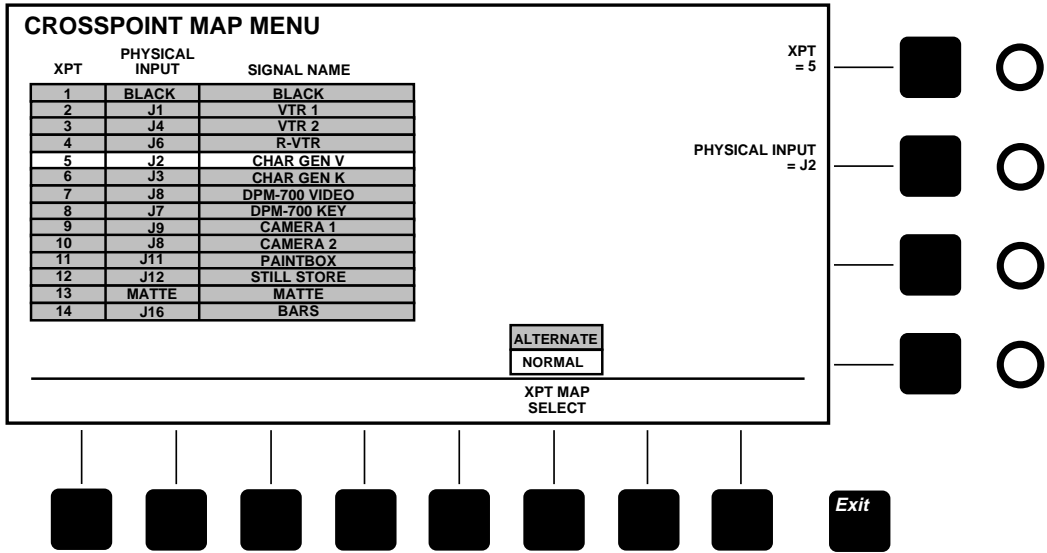

Figure 3-30. Crosspoint Map Menu

Outputs Menu

From the Configuration top menu, press **[OUTPUTS>]** to display the Outputs menu shown in Figure 3-31. This menu allows you to set parameters for each switcher output signal.

Outputs Menu Functions:

[OUTPUT]—Scrolls through the outputs in the display table, highlighting the current selection.

[BITS RES]—Sets the digital resolution of the highlighted output to **8** or **10** bits to match the resolution of the signal destination.

[SHAPING]—Sets shaping of the highlighted output **ON** or **OFF**. Turning shaping **ON** provides a video output that has been shaped (multiplied) by the key and matted over black. Turning shaping **OFF** provides a regular, unshaped video output.

[SIGNAL SOURCE]—Selects the highlighted output to consist of either **PROGRAM** (video with key) or **CLEAN** (video without key).

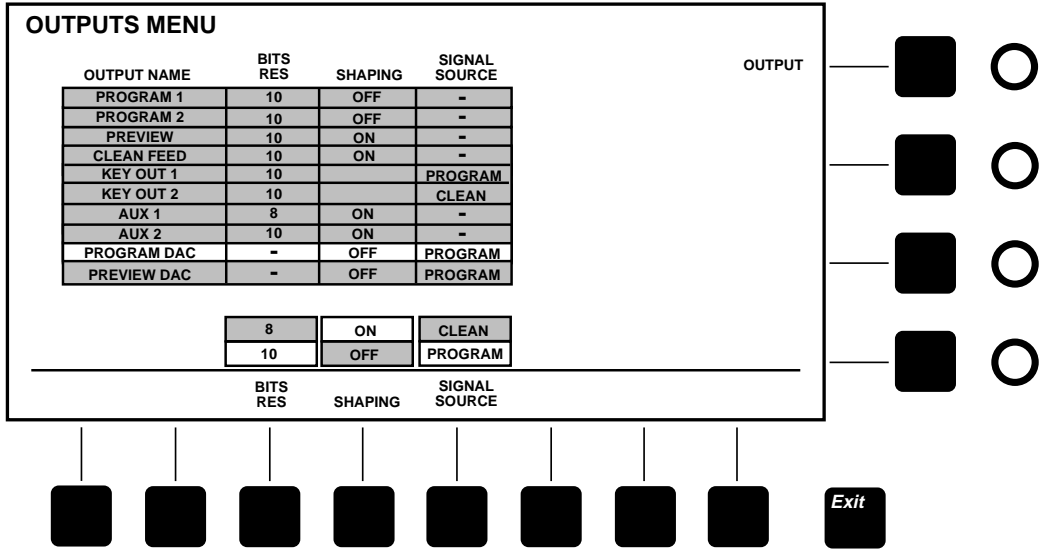

Figure 3-31. Outputs Menu

Timing Menu

From the Configuration top menu, press *[TIMING>]* to display the Timing menu shown in Figure 3-32. This menu allows you to advance or delay the timing of the Reference input. The *(REF TIMING FINE)* and *(COARSE)* soft knobs set Reference input timing. The *(COARSE)* knob sets rough timing, and the *(REF TIMING FINE)* knob fine-tunes the timing adjustment. As you change the reference timing, the display table updates to show the timing of the primary inputs changing with the reference. Output timing changes also but is not displayed in the table.

The purpose of adjusting reference timing is to advance or delay the switcher's auto timing window as required to capture all of the primary inputs.

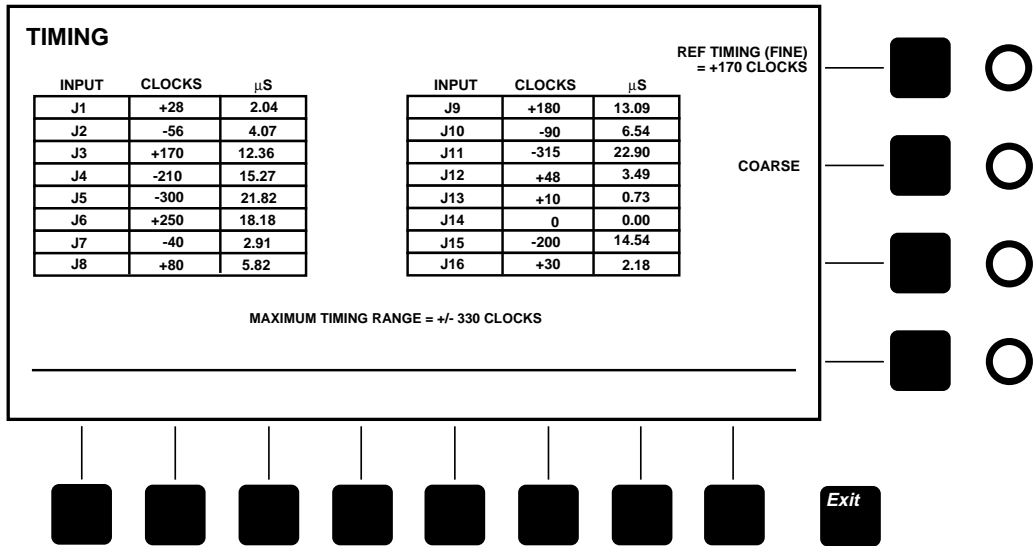

Figure 3-32. Timing Menu

Port Configuration Menu

From the Configuration top menu, press *[PORTS>]* to display the Port Configuration menu shown in Figure 3-33. This menu permits you to set the communication parameters of each switcher serial port.

Port Configuration Menu Functions:

(PORT)—Scrolls through the serial ports in the display table, highlighting the current selection.

(PROTOCOL)—Selects the serial “language” to be used by the highlighted port. Ports other than the panel port can be used for any purpose but are typically set as follows:

TTY—Any protocol. Select *TERMINAL* if connecting a terminal.

PANEL—Fixed *1200 PNL* protocol.

MODEM—Any protocol. Select *MODEM* if connecting a modem.

EDITOR—Any protocol. Select *1200* if connecting a Grass Valley editor. *110* or *200* will also work but with less functionality.

DPM—Any protocol. Select *DPM* if connecting a DPM.

(ADDRESS)—Sets the address for the highlighted port. Typically external devices such as editors and digital picture manipulators expect the switcher address to be *30H*.

(BAUD RATE)—Sets the baud rate (communication speed) for the currently selected port.

[FACTORY DEFAULT]—Resets the selected port to factory defaults. (Soft knob buttons do not restore defaults if double-pressed.)

[BITS]—Sets the number of data bits in each byte for the highlighted port.

[*PARITY*]*]*—Sets the parity for the highlighted port.

[*STOP BITS*]*]*—Sets the number of stop bits for the selected port.

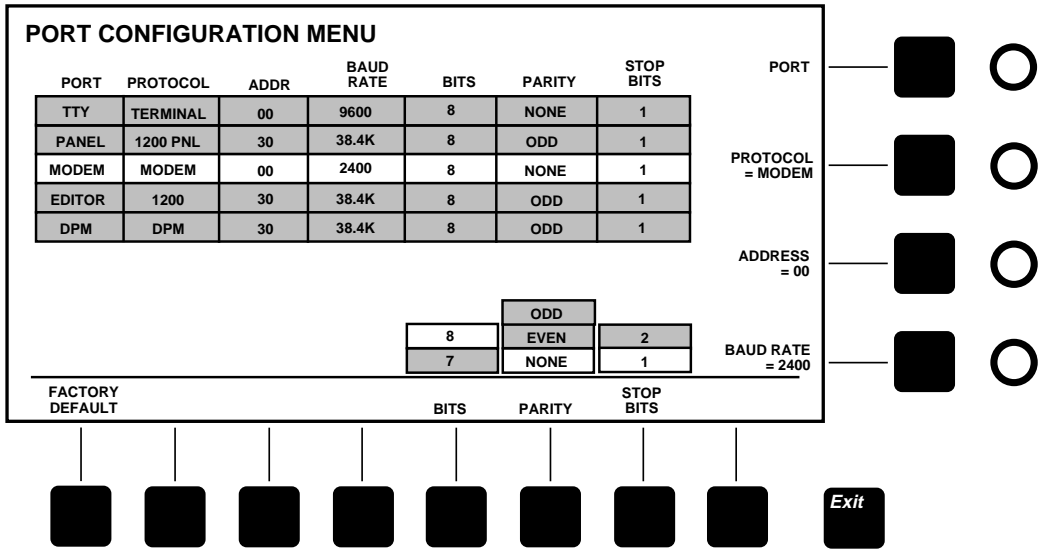

Figure 3-33. Port Configuration Menu

GPI Menus

The GPI Inputs menu (Figure 3-34) is displayed when you press the [**Config**] top menu button followed by the [*GPI>*] soft button. From this menu, you can access the GPI inputs and also the GPI Outputs menu (Figure 3-35). Together, these two menus allow you to assign, view, and test the 8 GPI inputs and 8 GPI outputs.

GPI inputs are trigger signals (Closed State) that come from external equipment via the GPI connector and start a specified event in the switcher, such as an auto transition. GPI outputs are triggers (Closed State) generated by switcher events that go out via the GPI connector to external devices to cause them to take some action.

GPI Input and Output Menu Functions:

(SELECT GPI INPUT/OUTPUT)—Highlights a GPI input or output.

(SELECT EVENT)—Assigns an event to the highlighted GPI.

[GPI OUTPUTS>]—Displays the GPI Outputs menu.

[GPI OUTPUT TEST]—When set to *ON*, cycles through each output, closing its relay for approximately 1/2 second. This allows you to check whether your GPI connections are working properly.

Two events deserve special mention:

The *ALTERNATE XPT MAP* selection allows you to use a GPI input to switch between two different crosspoint maps stored in the Crosspoint Map menu. This can be convenient when you have two different uses for the switcher, for example, a live news show and off-line post production.

The *AUX BUS TALLY BACK* selection uses the GPI as an input condition that the switcher detects in order to tally the selected aux bus crosspoint. This permits an external DPM to tally the aux buses when aux bus video is on air at the DPM. Aux tally back can be turned on and off in the Tally menu.

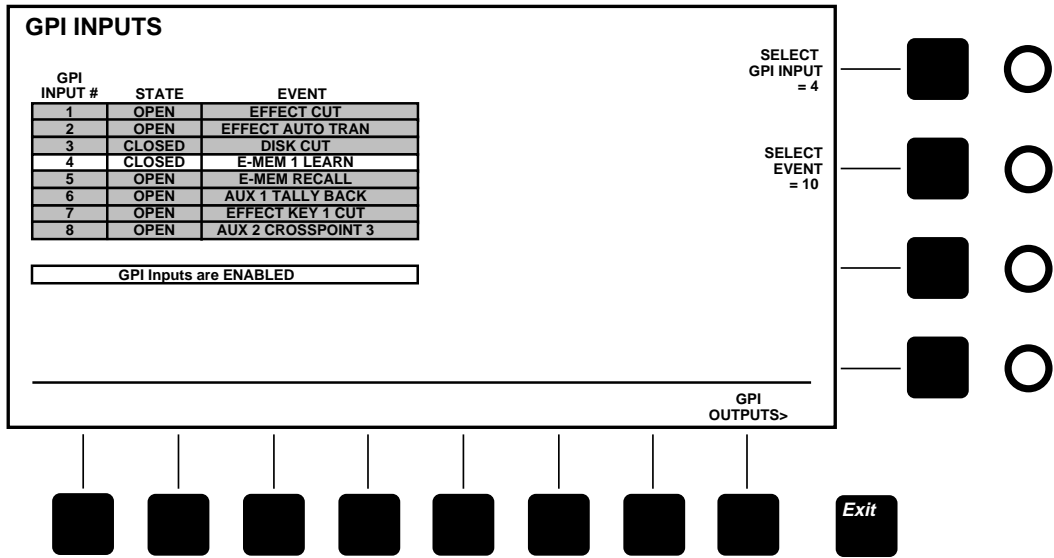

Figure 3-34. GPI Inputs Menu

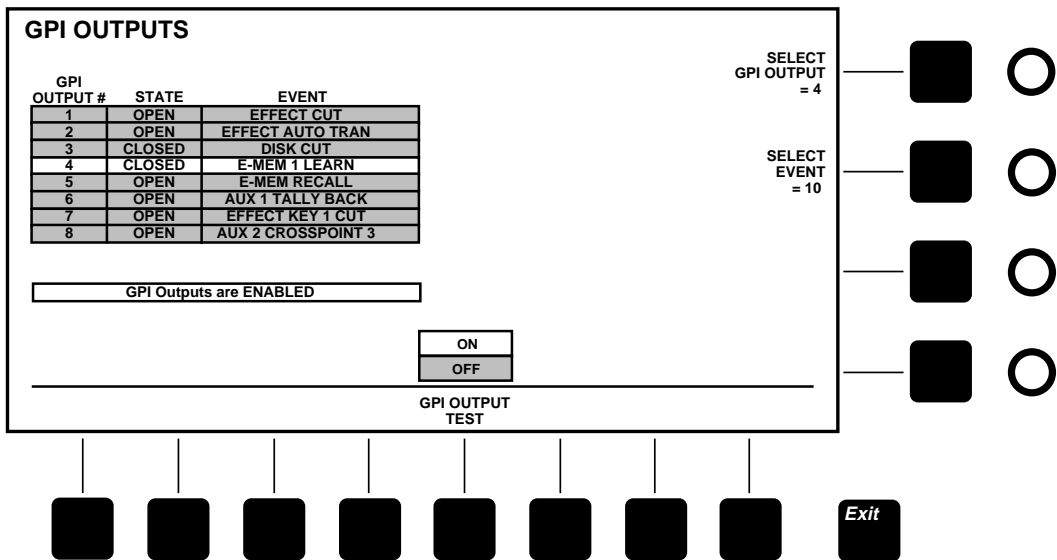

Figure 3-35. GPI Outputs Menu

Tally Menu

The Tally menu (Figure 3-36) is displayed when you press the **[Config]** top menu button followed by the **[TALLY>]** soft button. The Tally menu displays a table listing the 16 physical signal inputs, indicating those that are high-tallied by highlighting them.

Tally Menu Functions:

AUX TALLY BACK ON/OFF—(Aux Bus Tally Back) selection. Allows use of a GPI input to tally Aux Bus 1 whenever the effects send fill crosspoint is tallied and Aux Bus 2 whenever the effects send source crosspoint is tallied. This provides tally back from an external DPM. This feature must be enabled in the Tally menu and assigned as an event to a GPI input in the GPI Inputs menu.

[TALLY TEST]—When **ON**, this function cycles each output on for about 1/2 second. When finished testing, set the **[TALLY TEST]** button to **OFF**.

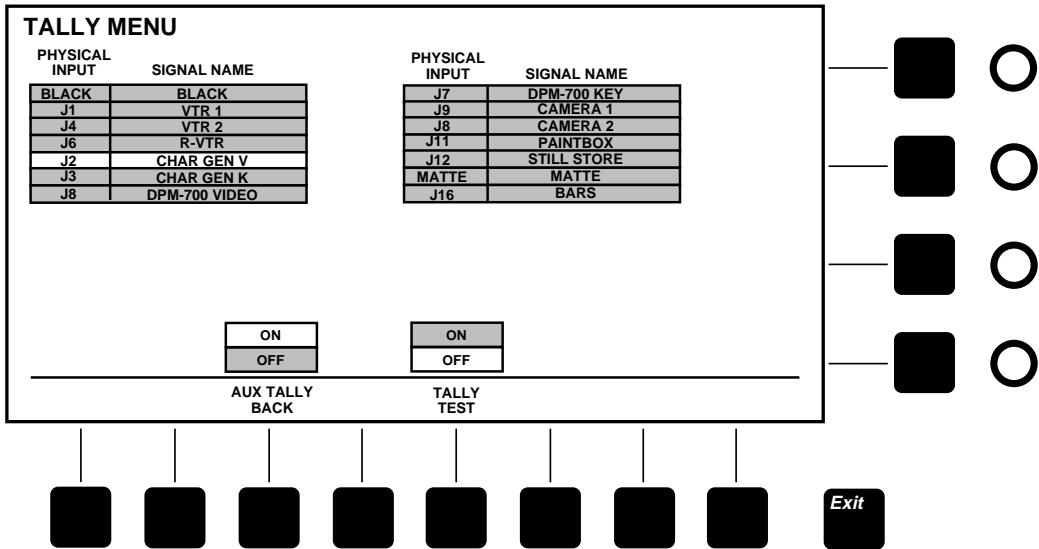

Figure 3-36. Tally Menu

Copy/Swap Menus

Press the [Copy Swap] top menu button to display the Copy/Swap Proc Amp top-level menu shown in Figure 3-37. This menu provides access to the Copy/Swap Keyer (see Figure 3-38), the Copy/Swap Matte (see Figure 3-39), and the Copy/Swap Border (see Figure 3-40) menus.

All of the Copy/Swap menus allow you to copy or swap settings from one selection to another. The common factors between these menus are:

- **[DO SWAP]** - Initiates a swap between selected items
- **[DO COPY]** - Copies the settings from one item to the other
- **[UNDO COPY]** or **[UNDO SWAP]** - After a copy or swap has been completed this allows you to return the settings to their original state

NOTE: Crosspoints with the same source and the Black and Matte crosspoints will not copy/swap.

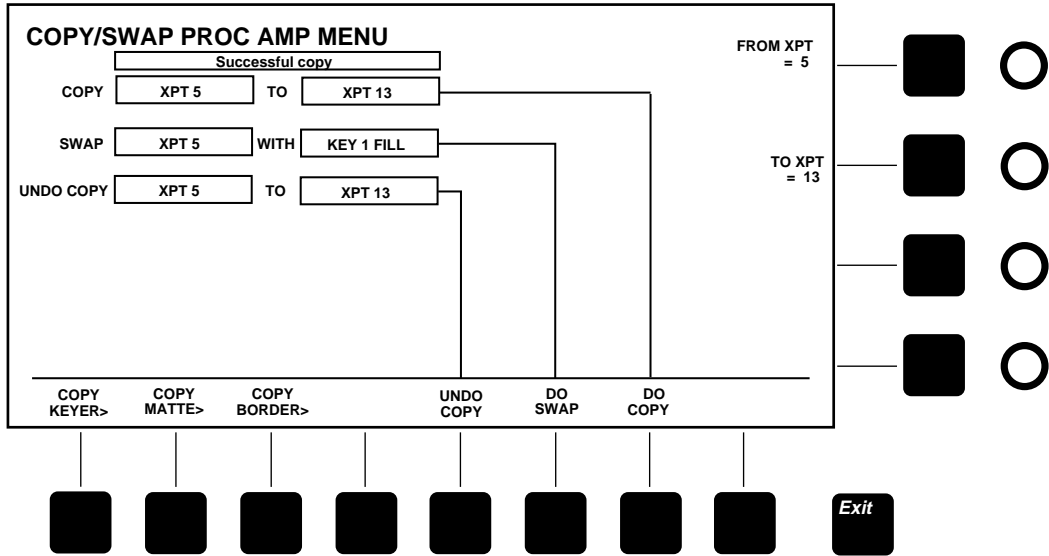

Figure 3-37. Copy/Swap Proc Amp Menu

The Copy/Swap Proc Amp menu is used to copy or swap crosspoint settings from one crosspoint to another. Select the TO and FROM crosspoints with the (*FROM XPT*) and (*TO XPT*) soft knobs.

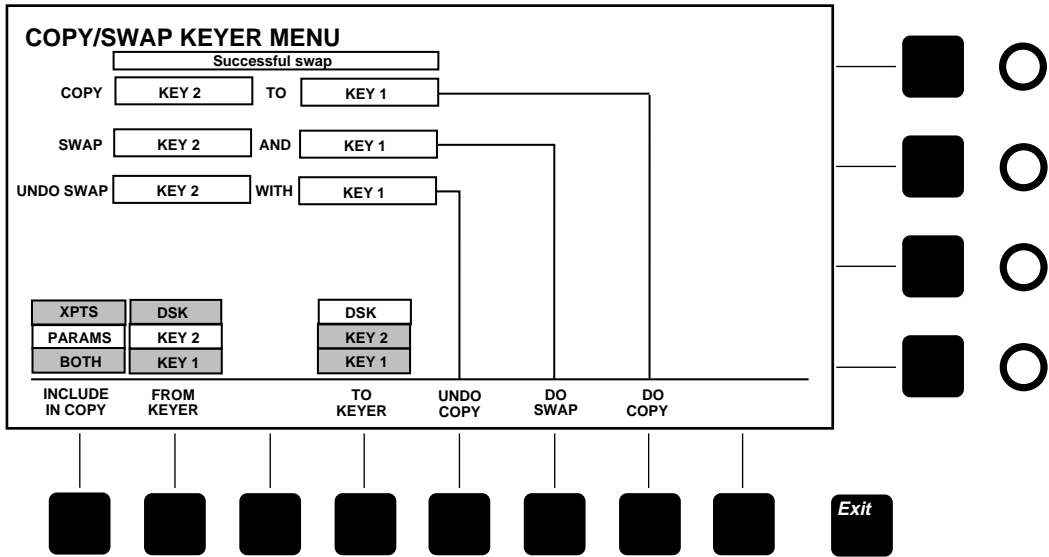

Figure 3-38. Copy/Swap Keyer Menu

The Copy/Swap Keyer menu is used to copy or swap crosspoint settings, parameter settings, or both of these settings from Key 1, Key 2, or DSK, to Key 1, Key 2 or DSK. Make the TO and FROM selection using the [FROM KEYER] and [TO KEYER] soft buttons. Select XPTS, PARAMS, or BOTH using the [INCLUDE IN COPY] soft button.

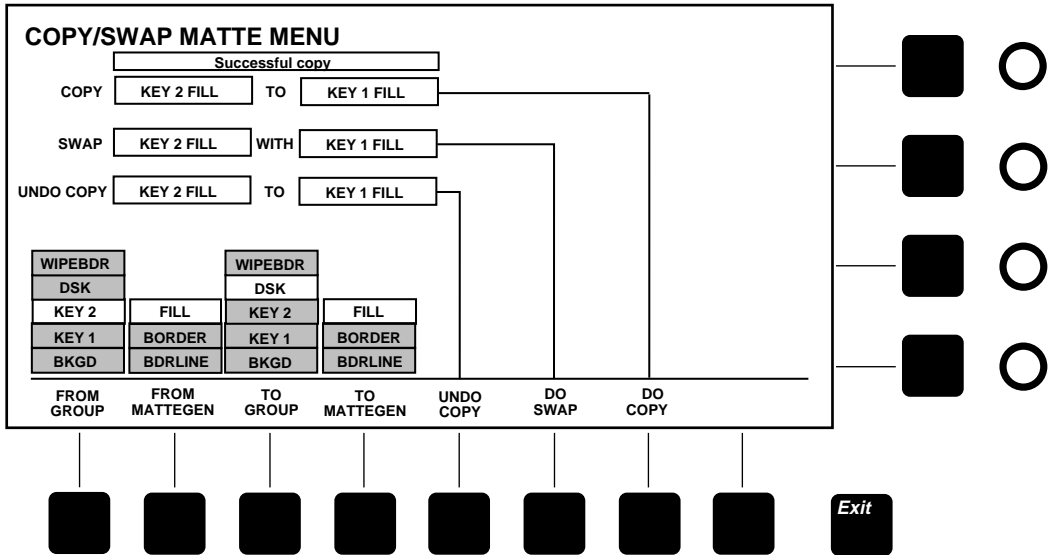

Figure 3-39. Copy/Swap Matte Menu

The Copy/Swap Matte menu is used to copy or swap matte colors from any matte generator to another. Make the FROM selection using the *[FROM GROUP]* and *[FROM MATTEGEN]* soft buttons. Make the TO selection using the *[TO GROUP]* and *[TO MATTEGEN]* soft buttons.

Note that the soft knob selection of *(FROM MATTE =)* and *(TO MATTE =)* will only appear when matte is selected in the *[FROM or TO GROUP]* selection. Also note that only crosspoints defined as mattes will appear here as selections to chose from.

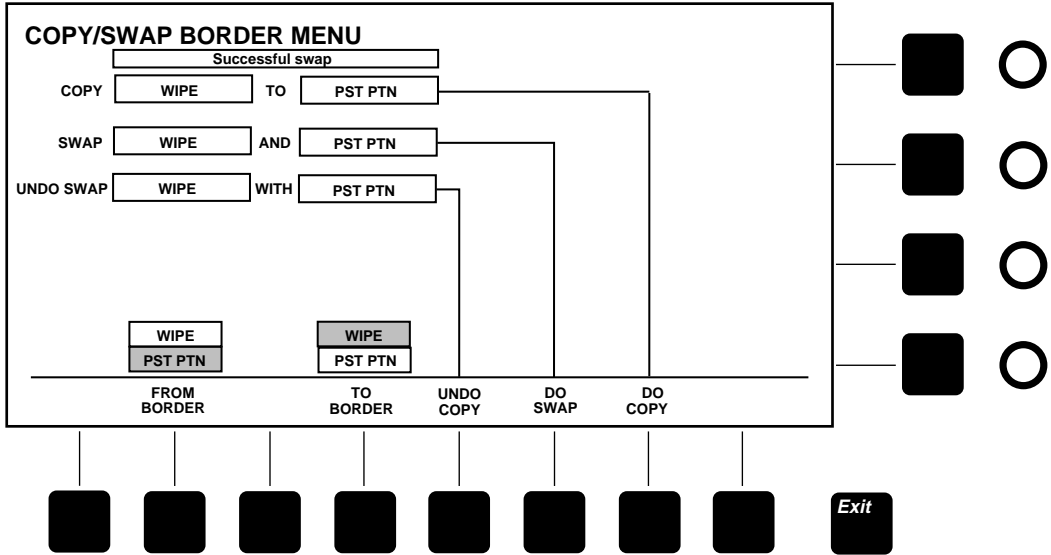

Figure 3-40. Copy/Swap Border Menu

The Copy/Swap Border menu is used to copy or swap a wipe border and a preset pattern border. Make the TO and FROM selection using the *[FROM BORDER]* and *[TO BORDER]* soft buttons.

Disk Menus

Press the white **[Disk]** top menu button to display the Disk menu shown in Figure 3-41. Navigation through the disk directories is similar to that done on personal computers. Disks are IBM PC compatible.

Disk Menu Functions:

[FILE SELECT]—Scrolls through the list of files and directories, highlighting one item at a time for selection.

[LIST DIR]—Lists the contents of the current directory. A directory listing occurs automatically when you enter the menu or change directories. The main purpose of this soft button is to update the directory after you change disks.

[CHANGE DIR]—Allows you to move to another directory. To do so, select the directory using **[FILE SELECT]** and then push the **[CHANGE DIR]** soft button.

[SAVE>]—Displays the Disk Save menu.

[LOAD>]—Displays the Disk Load menu.

[UTIL>]—Displays the Disk Utility menu.

[FORMAT>]—Displays the Disk Format menu.

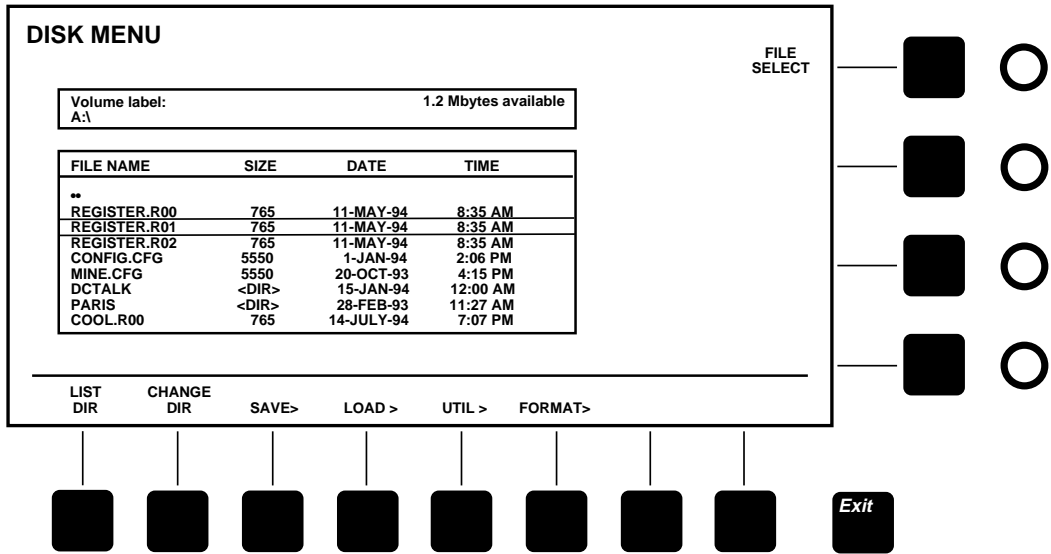

Figure 3-41. Disk Top Menu

Disk Save Menu

Press the *[SAVE>]* button to display the Disk Save menu shown in Figure 3-42. This menu allows you to save E-MEM registers, banks of registers, and configuration files (corresponding to the Configuration menus) to the floppy disk.

Disk Save Menu Functions:

(FILE SELECT)—Scrolls through the list of files and directories.

[LIST DIR]—Lists the contents of the current directory. A directory listing occurs automatically when you enter the menu or change directories. The main purpose of this soft button is to update the directory after you change disks.

[CHANGE DIR]—Allows you to move to another directory. To do so, select the directory using *(FILE SELECT)* and then push the *[CHANGE DIR]* soft button.

[SAVE E-MEM]—Saves the currently selected E-MEM register to the disk.

[SAVE BANK]—Saves the currently selected bank of E-MEM registers to the disk.

[SAVE ALL E-MEMS]—Saves all E-MEM registers to disk.

[SAVE CONFIG]—Saves the current switcher panel configuration to disk.

[SET NAME]—Allows you to enter a file name using the keyboard, or a special dial and button entry screen.

(E-MEM)—Selects an E-MEM register to be saved.

(BANK)—Selects a bank of E-MEM registers to be saved.

[ENTRY MODE]—Toggles between keyboard entry or a special dial and button entry screen for entering a file name.

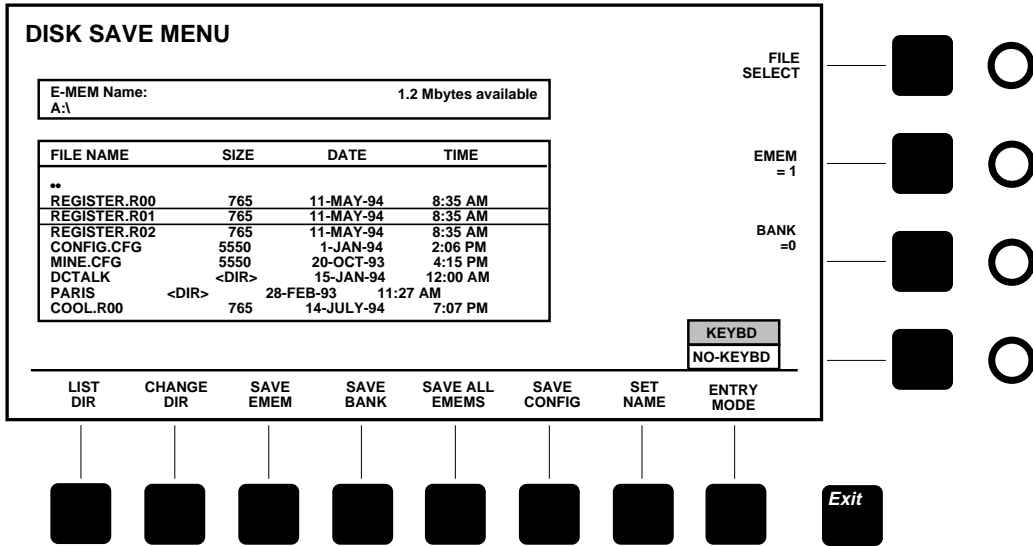

Figure 3-42. Disk Save Menu

Save Switcher Configuration to Disk

The [SAVE CONFIG] function allows you to save the current switcher configuration into a file.

A configuration save includes all the parameters you have set under the [Config] menu in addition to the status of the External Interface buttons located below the menu screen, the clip mode settings of the KEYER menu functions, the Aux TallyBack and Aux re-entry status, and the Effects Send Return fill/source crosspoints.

NOTE: *A configuration file will be saved with the extension suffix. CFG after the base name (REGISTER). The base name will be the default file name currently chosen on the display unless you change it by pushing [SET NAME] and enter a new file name. This is important to note because if you have saved a previous configuration under one file name and save a new configuration to that same file name, the old file will be overwritten with no warning message.*

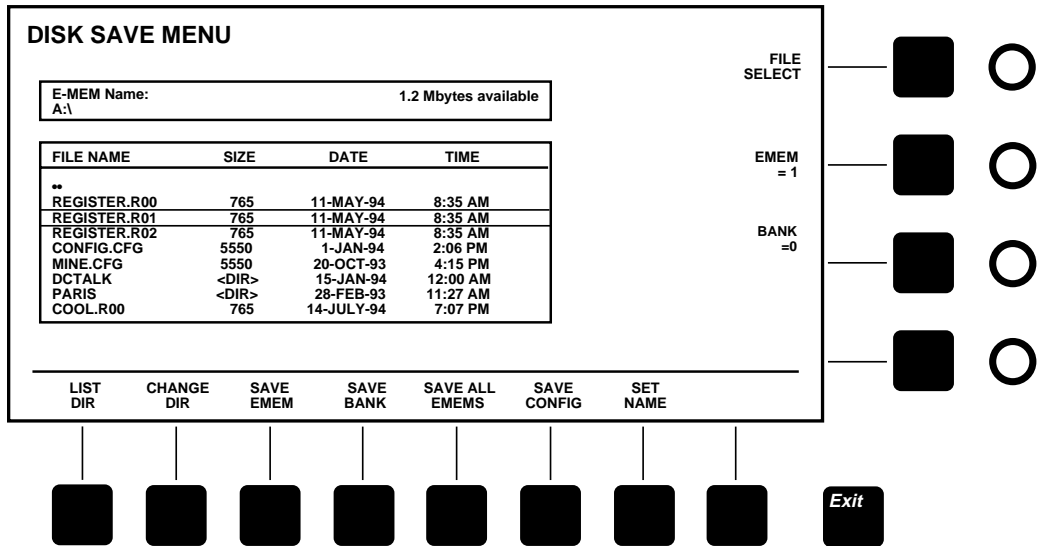

Figure 3-43. SAVE CONFIG in Disk Save Menu

Name File

The file Name (Figure 3-44) menu is found under the [Disk] top-level menu. From the Disk Menu screen the submenu path is:

- **File Name Menu** - Press [SAVE>] then [SET NAME] to access the menu

NOTE: *You may use an external keyboard to enter these characters if so desired. These menus will not appear if a keyboard is attached to the control panel.*

1. Select each character by turning the soft knobs located to the right of the menu display.
2. Enter the selected character by pressing the [ACCEPT CHAR] soft button. The new character will be displayed in the menu.
3. Continue selecting characters in this manner until the name is spelled out in the menu.
4. Press [ACCEPT NAME] to store the name. The system automatically returns to the previous menu.

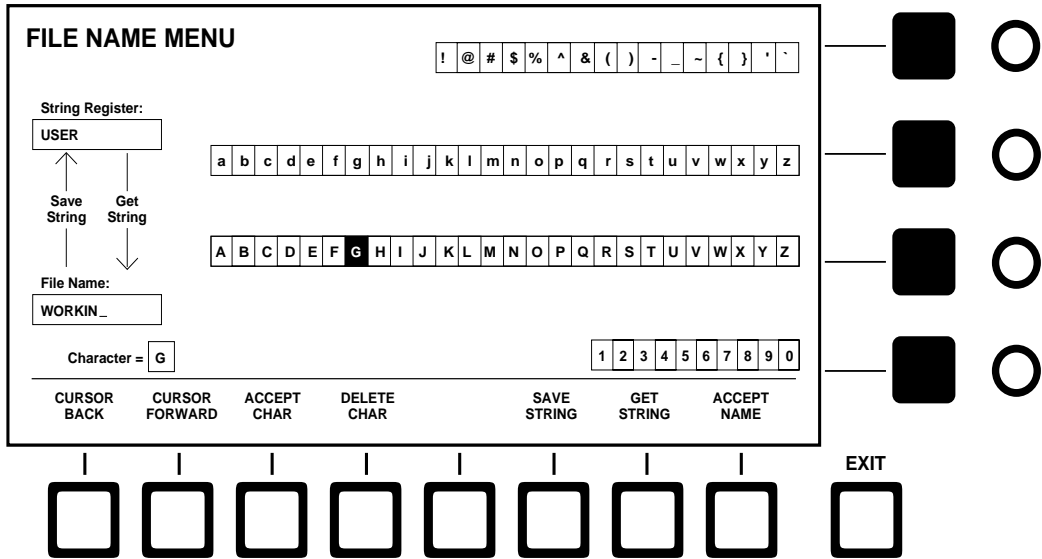

Figure 3-44. File Name Menu

Disk Load Menu

Press the **[LOAD>]** button to display the Disk Load menu shown in Figure 3-45. This menu allows you to load E-MEM registers, banks of registers, and configuration files (saved settings from the Configuration menus) from the floppy disk into the switcher.

Disk Load Menu Functions:

[FILE SELECT]—Scrolls through the list of files and directories.

[LIST DIR]—Lists the contents of the current directory. A directory listing occurs automatically when you enter the menu or change directories. The main purpose of this soft button is to update the directory after you change disks.

[CHANGE DIR]—Allows you to move to another directory. To do so, select the directory using **[FILE SELECT]** and then push the **[CHANGE DIR]** soft button.

[MARK FILE]—Marks a file for loading.

[LOAD MKD REGS]—Loads marked E-MEM register files from the disk into the switcher's E-MEM registers.

[LOAD ALL]—Loads all E-MEM registers files from the disk into the switcher's E-MEM registers.

[LOAD MKD CFG]—Loads the marked configuration file from the disk to the switcher configuration menus.

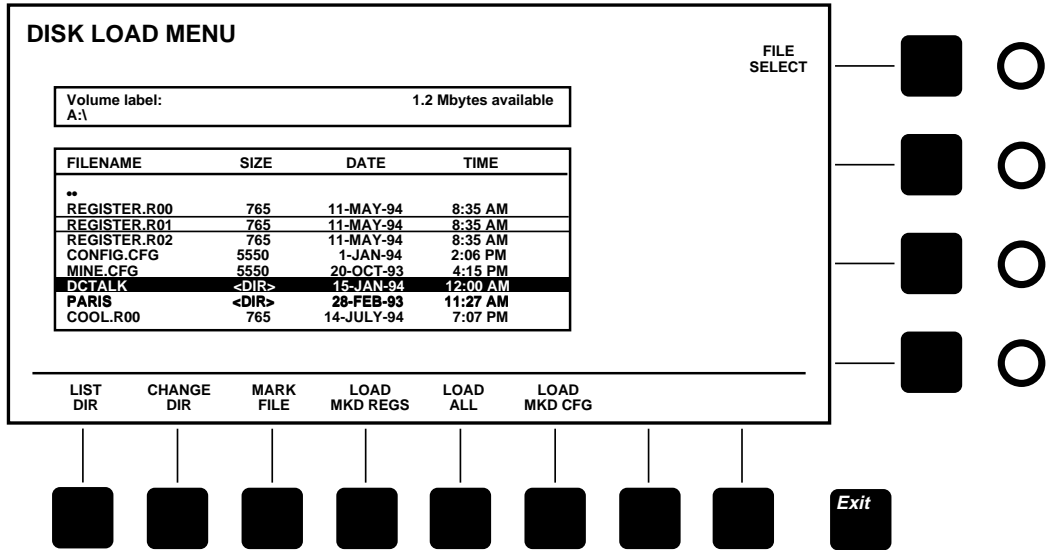

Figure 3-45. Disk Load Menu

Load Configuration and Load All

The [LOAD MKD CFG] function allows you to download from disk the marked switcher configuration into the switcher to become the current configuration.

The [LOAD ALL] function allows you to mark any E-MEM register file in the listed directory. Pressing the [LOAD ALL] menu button will load all E-MEM files that have the same base name (the base name is the characters before the extension). Only one E-MEM register base name should be marked; if more than one is marked you will receive an error message.

NOTE: In the [LOAD ALL] function, although only one register file needs to be marked to load all the similar base name registers, more than one file can be marked if desired. However, make sure all base names selected are the same, or an error message will appear.

Disk Util Menu

Press the *[UTIL>]* button to display the Disk Util menu shown in Figure 3-46. The Utility menu allows you to perform routine disk operations such as deleting files and making directories.

Disk Load Menu Functions:

(FILE SELECT)—Scrolls through the list of disk files and directories.

[LIST DIR]—Lists the contents of the current directory. A directory listing occurs automatically when you enter the menu or change directories. The main purpose of this soft button is to update the directory after you change disks.

[CHANGE DIR]—Allows you to move to another directory. To do so, select the directory using *(FILE SELECT)* and then push the *[CHANGE DIR]* soft button.

[MARK FILE]—Marks files for locking, unlocking, or deletion.

[DELETE MARKED]—Deletes marked files. Pressing this soft button displays a Delete confirmation dialog with Confirm and Cancel buttons. If you press *[CONFIRM]*, the marked files will be deleted. If you press *[CANCEL]*, the deletion will be cancelled.

[LOCK/UNLOCK]—Locks marked files so they cannot be deleted. Also unlocks previously locked files.

[MAKE DIR]—Creates a new file directory on the disk and allows you to name the file using the keyboard.

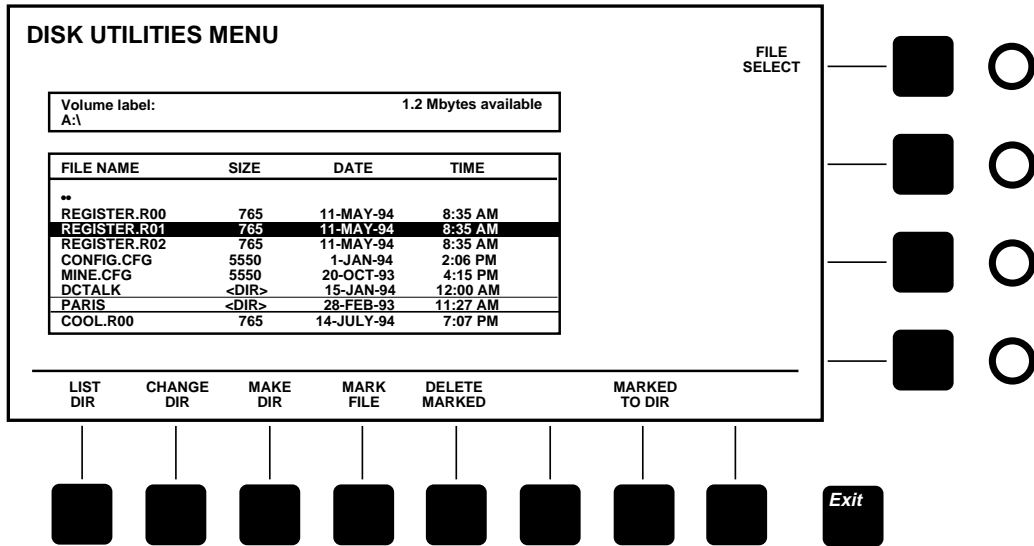

Figure 3-46. Disk Util Menu

Moving Files to Other Directories

The Disk Utilities menu allows you better file management. All marked files (highlighted) can be moved to either a sub-directory or a higher parent directory.

To move files:

1. Mark all files to be moved.
2. Move the cursor bar to either the sub-directory name or to the parent directory (••).
3. Press the **[MARKED TO DIR]** soft menu button.

NOTE: If a file with the same name as a marked file already exists in the directory, an error message will appear and stop the transfer process.

Name Directory

The Directory Name (Figure 3-47) menu is found under the [Disk] top-level menu. From the Disk Menu screen the submenu path is:

- **Directory Name Menu** - Press [UTIL>] then [MAKE DIR] to access the menu

NOTE: *You may use an external keyboard to enter these characters if so desired. These menus will not appear if a keyboard is attached to the control panel.*

1. Select each character by turning the soft knobs located to the right of the menu display.
2. Enter the selected character by pressing the [ACCEPT CHAR] soft button. The new character will be displayed in the menu.
3. Continue selecting characters in this manner until the name is spelled out in the menu.
4. Press [ACCEPT NAME] to store the name. The system automatically returns to the previous menu.

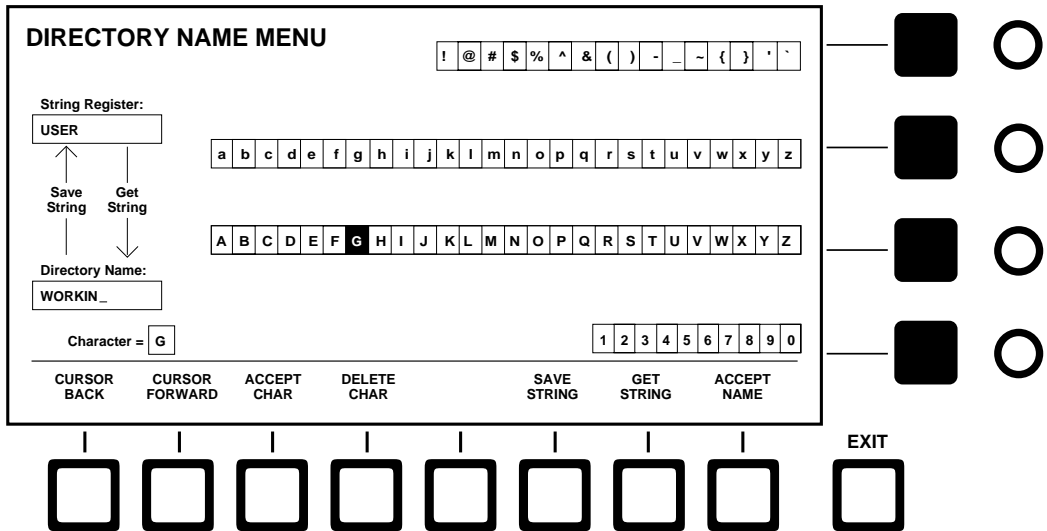

Figure 3-47. Directory Name Menu

Disk Format Menu

Press the *[FORMAT>]* button to display the Disk Format menu shown in Figure 3-48. This menu allows you to format floppy disks. Formatted disks are IBM PC compatible.

Disk Format Menu Functions:

[FORMAT 1.44M]—Formats the disk for 1.44 megabytes

[FORMAT 720K]—Formats the disk for 720 kilobytes.

When you choose one of the format soft buttons, a dialog will appear, asking you to confirm the format. To continue with the formatting, press the *[CONFIRM]* soft button; to cancel formatting, press the *[CANCEL]* button. During formatting, another dialog will ask you to enter a disk name; enter the name using the keyboard.

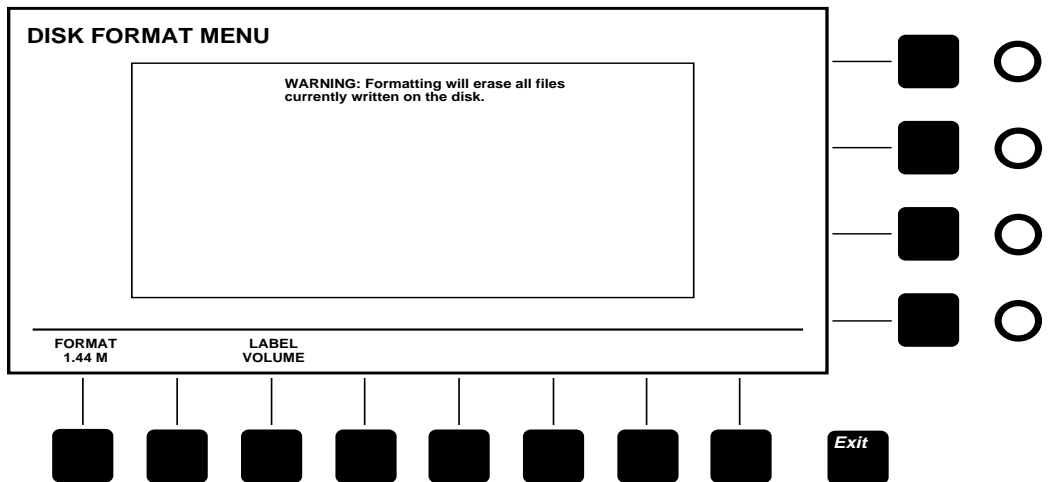

Figure 3-48. Disk Format Menu

Name Volume

Three new menus have been created to allow naming of the disk volumes, directories and Files. The Volume Name (Figure 3-49), menu is found under the [Disk] top-level menu. From the Disk Menu screen the submenu path is:

- **Volume Label Menu** - Press *[FORMAT>]* then *[LABEL VOLUME]* to access the menu

NOTE: *You may use an external keyboard to enter these characters if so desired. These menus will not appear if a keyboard is attached to the control panel.*

1. Select each character by turning the soft knobs located to the right of the menu display.
2. Enter the selected character by pressing the *[ACCEPT CHAR]* soft button. The new character will be displayed in the menu.
3. Continue selecting characters in this manner until the name is spelled out in the menu.
4. Press *[ACCEPT NAME]* to store the name. The system automatically returns to the previous menu.

NOTE: *The Volume Label menu will accept names of up to eleven characters. The Directory Name, and the File Name menus will accept names of up to eight characters.*

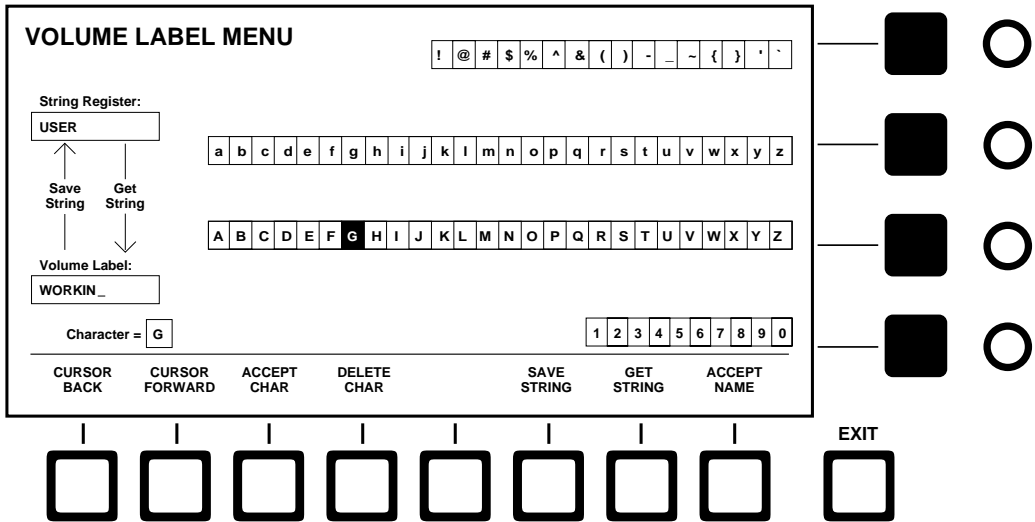

Figure 3-49. Volume Label Menu

Keyer Menu

Press the white **[Keyer]** top menu button to display the Keyer menu shown in Figure 3-50. This menu includes delegation controls that duplicate the panel delegation buttons. It also provides precise control over Opacity and Clip/Gain or Opacity and Foreground Clip/Background Clip.

Keyer Menu Functions:

[CLIP MODE]—Toggles the keyer controls (in the menu and on the panel) between clip/gain mode and foreground/background clip mode. In **CLIP/GAIN** mode, the **(CLIP)** and **(GAIN)** controls adjust the clip and gain levels of the foreground. In **FGD/BKGD** mode, the **(FOREGROUND CLIP)** control adjusts the clip level of the foreground fill video, and the **(BACKGROUND CLIP)** control adjusts the clip level of the background video.

[KEY MEMORY]—Turns Key Memory **OFF** or **ON** for all keyers. When Key memory is on, pressing a Key bus crosspoint recalls the complete keyer setup last used for that crosspoint.

(KEYER SELECT)—Delegates the display and soft controls to one of the three keyers.

(OPACITY)—Adjusts the key video between transparent and fully opaque.

(CLIP)—Adjusts the key foreground fill video clip level. The **(CLIP)** control becomes available only when **CLIP/GAIN** mode is selected.

(GAIN)—Adjusts the gain of the key, which primarily affects the transition between foreground and background at the key edges. The **(GAIN)** control becomes available only when **CLIP/GAIN** mode is selected.

(BACKGROUND CLIP)—Adjusts the clip level of the key background video. This control becomes available only when **FGD/BKGD** mode is selected.

(*BACKGROUND CLIP*)—Adjusts the clip level of the key foreground fill video. This control becomes available only when *FGD/BKGD* mode is selected.

[*CLEAR KEYER*]—Returns all the keyer parameters to the default selections.

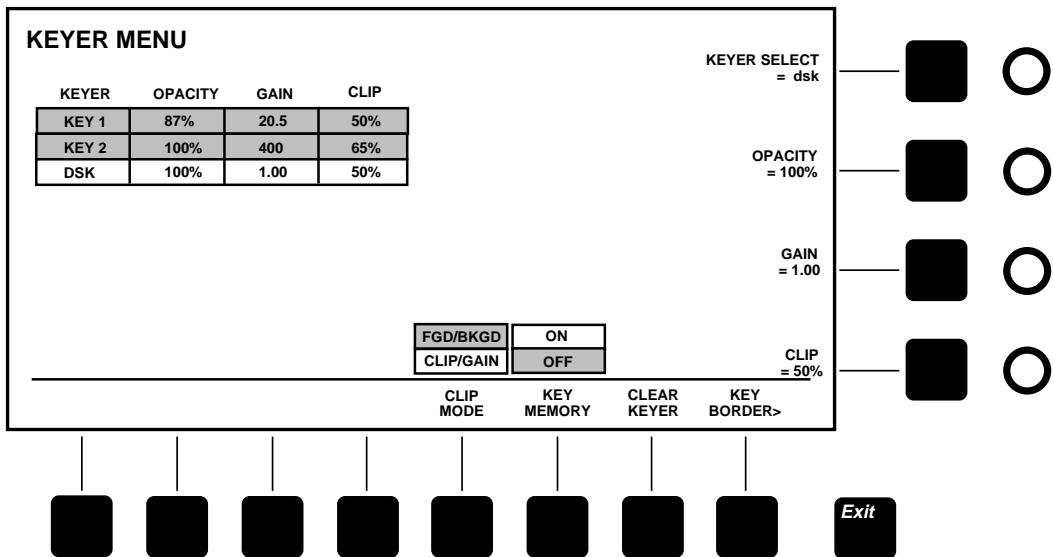

Figure 3-50. Keyer Menu

Key Border

Press the *[KEY BORDER>]* soft button to access the Key Border position menu. Refer to Figure 3-51.

NOTE: *You must have a BORDERLINE® option installed to have key bordering capability.*

Use the Key Border menu to change the horizontal and vertical positions of the key border on Key 1, Key 2, or the DSK. This can also be done using the original method with the pattern positioner as described in the Model 1200 manual.

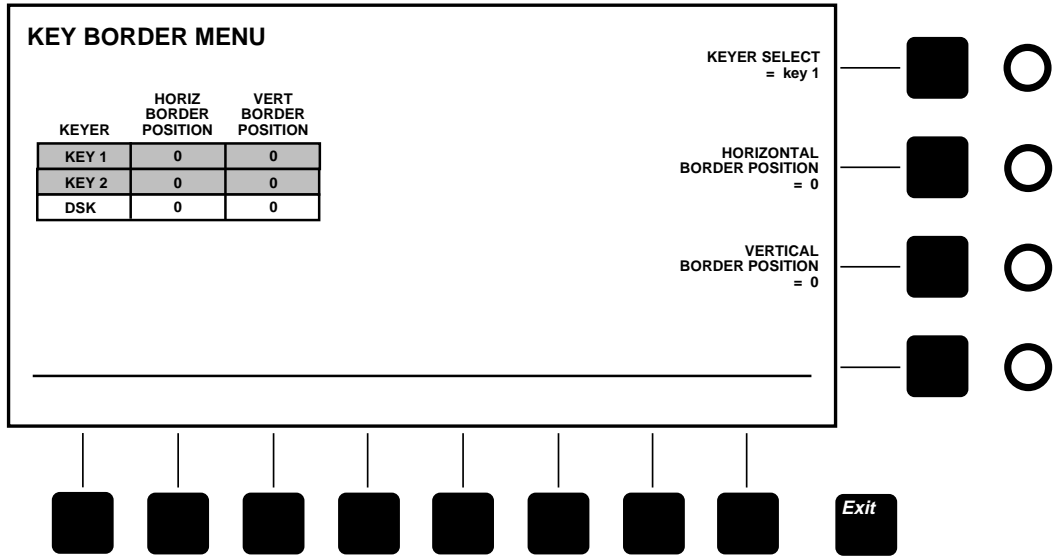

Figure 3-51. Key Border Menu

Last Menu

The **[Last Menu]** top menu button does not display a menu of its own. Instead it brings up the last menu, the menu you had been viewing before the current menu.

Misc Menu

Press the **[Misc]** top menu button to display the Miscellaneous menu shown in Figure 3-52.

[CLEAR WORK BUFFER]—Clears button and knob settings and returns them to their default state. The working buffer is the area where the current panel setup is stored.

[CLEAR DP RAM]—Completely clears the dual-port RAM, which is the memory where the working buffer and E-MEM data reside. This clear function erases all E-MEM registers.

[FACTORY RESET]—Clears all configuration, input mapping, E-MEM, and current working buffer data and resets the system to the state it was in when shipped from the factory.

[CONFIRM], [CANCEL]—Whenever you select **[CLEAR DP RAM]** or **[FACTORY RESET]**, a dialog box appears asking you to confirm or cancel the clear/reset. To continue with the clear/reset, press the **[CONFIRM]** soft button. To cancel the clear/reset, press the **[CANCEL]** soft button. This dialog protects you from accidentally erasing your E-MEM registers and configurations.

[LAMPSAVER DELAY]—Allows you to set the number of minutes that the switcher may be idle before the control panel lamps and displays turn off. LampSaver mode reduces lamp burnout by allowing the panel to “sleep” when not in use.

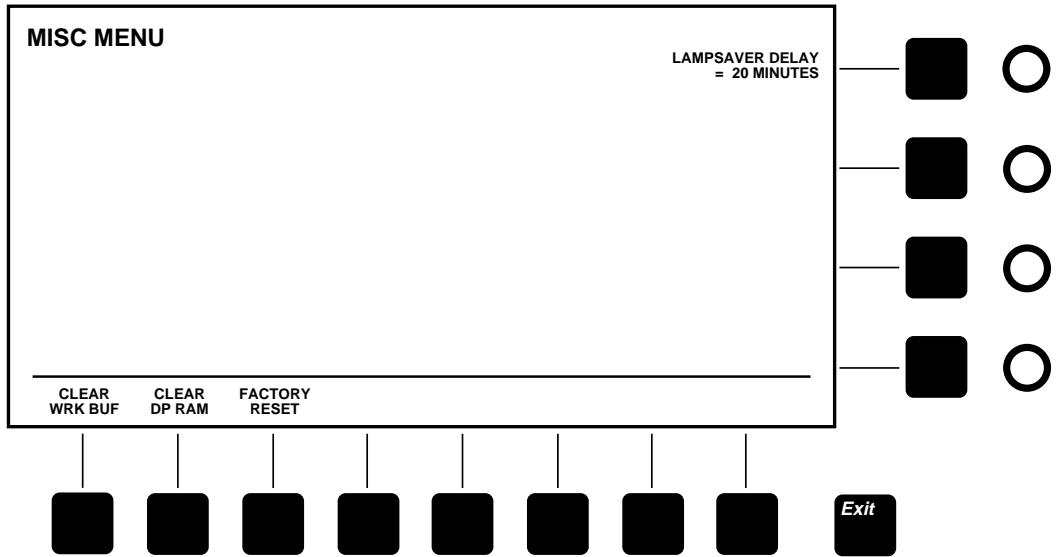

Figure 3-52. Miscellaneous Menu

Priority/Depth Menu

Press the white **[Prior/Depth]** top menu button to display the Priority/Depth menu shown in Figure 3-53. This menu gives you control of the priority and (optional) depth of the effects keyers.

Priority/Depth Menu Functions:

[Z-KEY DEPTH MODE]—Switches the effects keyers between Depth and Priority modes. In Priority mode, the keyers have no depth but the **(PRIORITY)** soft knob sets which key appears on top. In (optional) Depth mode, you can adjust the key layers to appear at different depths. **(KEY 1 DEPTH)**, **(KEY 2 DEPTH)**, and **(DEPTH SOFTNESS)** allow you to adjust the depth of each key layer and the softness of the mix at any point where they intersect. If the optional Depth board is not installed, the **Z-KEY MODE** selection is not displayed.

[JOYSTICK Z DELEGATION]—Delegates the joystick to control the priority of the key layers or their depth when Depth mode is selected. The various selections allow independent depth control of Key 1 or Key 2 or the relationship of Key 1 and Key 2 together. If the optional Depth board is not installed, the **JOYSTICK Z DELEG** function offers only two selections: **OFF** and **PRIORITY**, and the **KEY DEPTH** and **DEPTH SOFTNESS** knobs are not displayed.

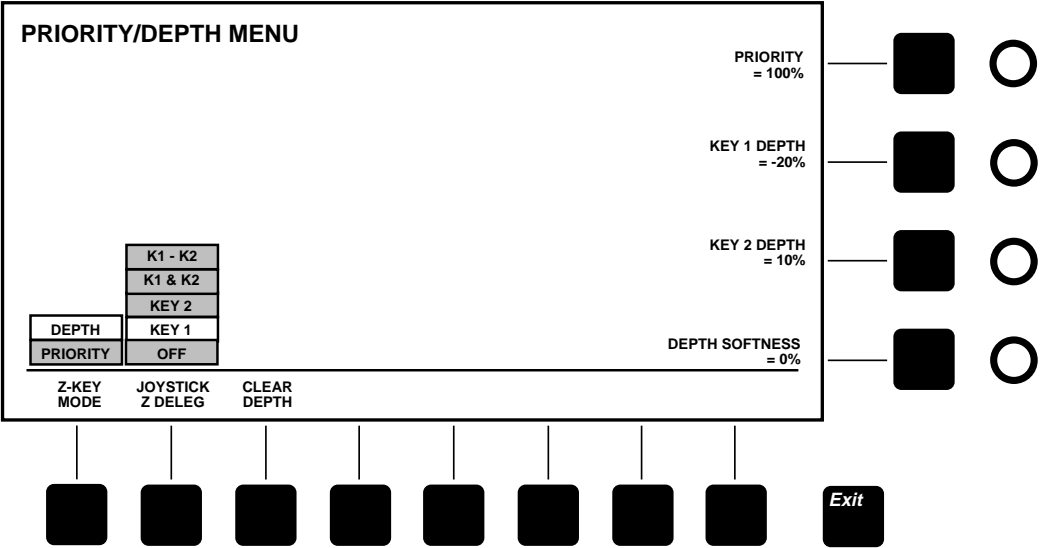

Figure 3-53. Priority/Depth Menu

Proc Amp Menus

Press the white **[Proc Amp]** top menu button to display the Proc Amp menu shown in Figure 3-54. This menu allows you to adjust the processing amplifier for each column of crosspoints.

Proc Amp Menu Functions:

(XPT SELECT)—Highlights a crosspoint in the display table for processing amplifier adjustment.

[CLEAR PROC AMP], [CLEARALL PROC AMPS]—These two selections allow you to clear a proc amp for a particular crosspoint or clear all proc amps to standard settings.

[PROC AMP ENABLE]—Turns processing amplifiers on or off for all crosspoint buses.

[MORE PROC>] displays additional processing amplifier adjustments.

(LUMA GAIN)—Adjusts the range of luminance (brightness).

(LUMA OFFSET)—Adjusts the dc base level of luminance.

(CHROMA SATURATION)—Adjusts color saturation.

(HUE)—Appears when you select *[MORE PROC]*. Adjusts the hue of the colors.

(U OFFSET)—Appears when you select *[MORE PROC]*. Adjusts offset of U color component. A positive U value adds more blue to the picture. Negative U adds more yellow to the picture.

(V OFFSET)—Appears when you select *[MORE PROC]*. Adjusts offset of the V color component. A positive V value adds more red to the picture. Negative V adds more green.

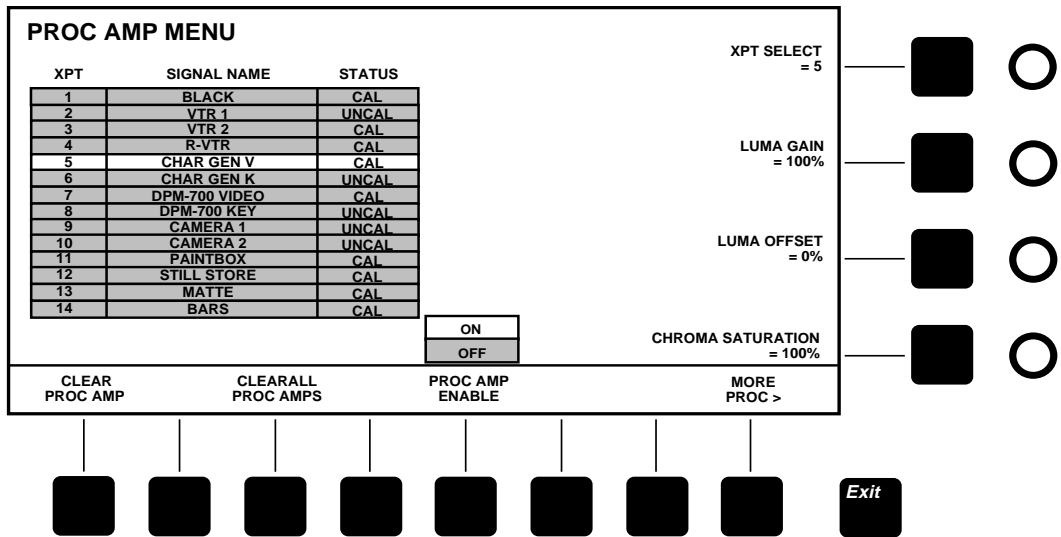

Figure 3-54. Proc Amp Menu

Status Menu

Press the white **[Status]** top menu button to display the Status top-level menu shown in Figure 3-55. This menu lists system software and circuit board part numbers and revision levels.

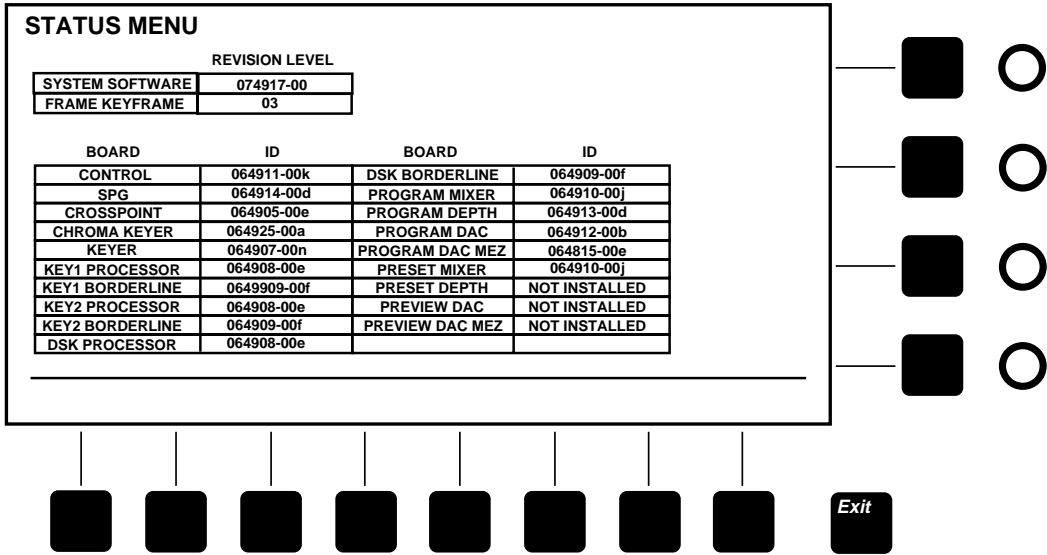

Figure 3-55. Status Menu

Wipe Menus

Press the white **[Wipe]** top menu button to display the Wipe top-level menu shown in Figure 3-56.

Wipe Menu Functions:

(PATTERN SELECT)—Scrolls through the pattern display.

[ASPECT]—Turns the Aspect adjustment on or off. When turned **OFF**, the pattern returns to its normal shape. When turned **ON**, the pattern returns to its last aspect setting.

(ASPECT)—Adjusts aspect or angle of the pattern.

[ROTATION]—Selects a rotation parameter to apply to the pattern. The **[OFF]** selection turns rotation off and returns the pattern to its default fixed position.

(ROTATION ANGLE)—Rotates the pattern to a new fixed position.

[PATTERN SCAN]—Selects **EVEN**, **ODD**, or **INTERLACE** operation: For proper pattern generating, one of the two frames used in Progressive Scan is set to “even” and the other set to “odd.” If your system is not being used for Progressive Scan, **INTRLACE** should be selected for interlace pattern generation.

[MULT>]—Displays the Wipe Multiply menu.

[MOD>]—Displays the Modulation menu.

[CLEAR PATTERN]—The wipe pattern characteristics you have assigned (modulation etc.) will be cleared and the pattern will return to default settings.

[CENTER PATTERN]—The wipe pattern will return to center. This is useful if the pattern has been moved out of view with the positioner.

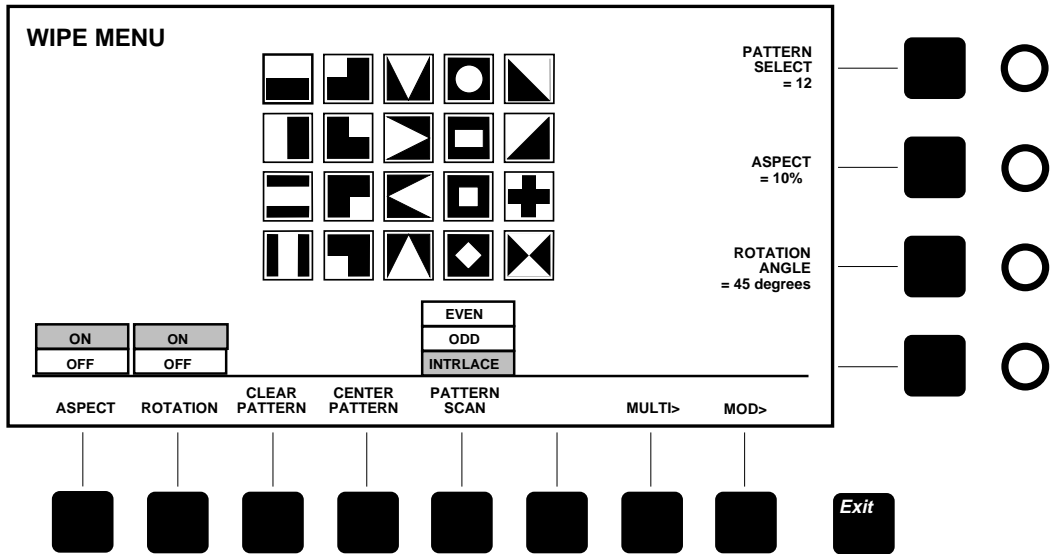

Figure 3-56. Wipe Top Menu

Wipe Multiply Menu

Press the *[MULT>]* button in the Wipe menu to display the Wipe Multiply menu shown in Figure 3-57.

Wipe Multiply Menu Functions:

[HORIZ MULT]—Turns horizontal multiplication of the pattern *ON* or *OFF*. When *ON*, a soft knob sets the number of multiples. When *OFF*, the number of multiples returns to one.

(HORIZONTAL MULTIPLY)—Sets the number of horizontal multiples.

[VERT MULT]—Turns vertical multiplication of the pattern *ON* or *OFF*. When *ON*, a soft knob sets the number of multiples. When *OFF*, the number of multiples returns to one.

(VERTICAL MULTIPLY)—Sets the number of vertical multiples.

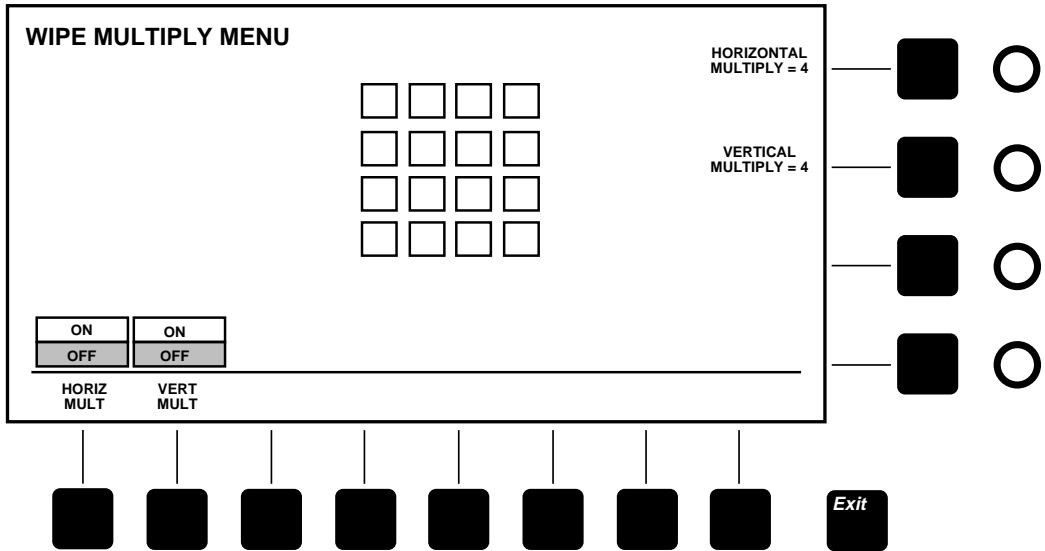

Figure 3-57. Wipe Multiply Menu

Wipe Modulation Menu

Press the **[MOD>]** button in the Wipe menu to display the Modulation menu shown in Figure 3-58.

Wipe Modulation Menu Functions:

[HORIZ MOD]—Selects the horizontal modulation mode applied to the pattern. If **TRIANGLE** is selected, the horizontal edges of the pattern are rippled by a triangle wave. If **SINE** is selected, the horizontal edges are rippled by a sine wave. **OFF** turns off horizontal modulation.

[VERT MOD]—Selects the vertical modulation mode applied to the pattern. If **TRIANGLE** is selected, the vertical edges of the pattern are rippled by a triangle wave. If **SINE** is selected, the vertical edges are rippled by a sine wave. **OFF** turns off vertical modulation.

(AMPLITUDE)—Sets the amplitude of the modulation.

(FREQUENCY)—Sets the frequency of the modulation.

(PHASE)—Sets the phase of the modulation.

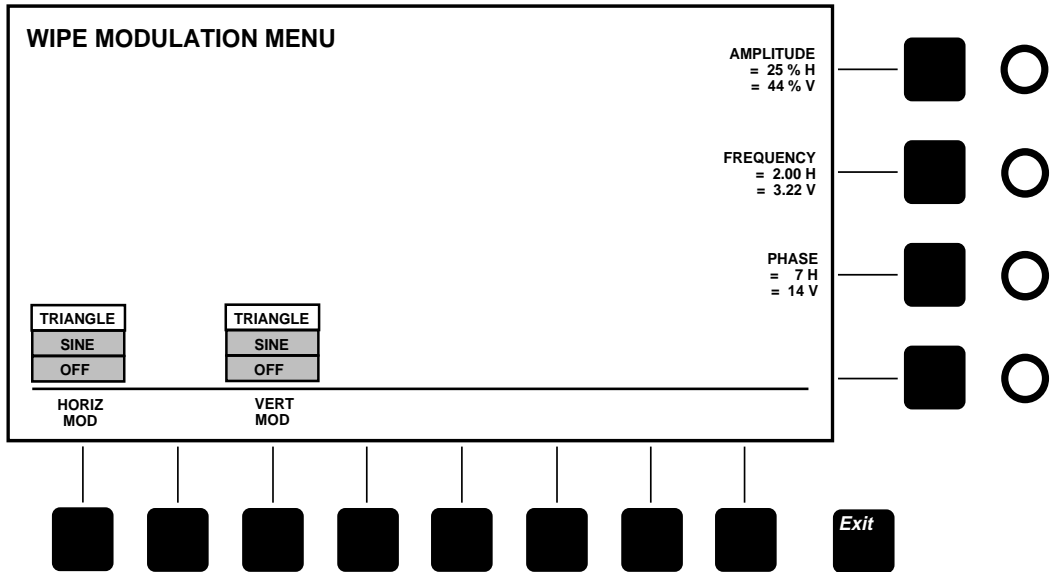

Figure 3-58. Wipe Modulation Menu

Readout Display Option

With this option installed, the Model 1200 can display crosspoint names (up to four characters each) on the display below the Aux Bus crosspoints on the control panel. The displayed crosspoint names are defined using either a keyboard or the Local Name Menu (shown earlier).

4

Basic Operations

Introduction

This section of the Operation manual demonstrates basic operation of the Model 1200 switcher. Each effect is presented step-by-step, making learning easy even if you're using a video switcher for the first time. If you are new to video switching or if you encounter terms in this section that you aren't familiar with, read "Concepts You'll Need to Know" in the "Startup" section. When you have finished working through this section, go on to the next section to learn more advanced operations.

The following major topics are included in this section:

- Transitions—page 4-2
- Matte Effects—page 4-8
- Luminance and Linear Keying—page 4-9
- Preset Pattern Keying—page 4-13
- Chroma Keying—page 4-15
- Using E-MEM Effects Memory—page 4-17

Starting Conditions

To ensure predictable results, before you do any of the following procedures, set the switcher to a known state:

1. Press the **[Misc]** button located left of the menu display. The Miscellaneous menu will appear in the menu display.
2. Press the **[CLEAR WORK BUFFER]** soft button below the menu display. This clears the panel to its default state.

Transitions

A transition is a change from one picture to another. This change can take the form of a cut, a mix, or a wipe and can be used to switch background scenes or insert or remove a key. Procedures for various transitions are presented on the following pages.

Background Cut

A cut is an instantaneous switch from one picture to another. It's the simplest type of transition between scenes. To cut between Program and Preset Background bus sources, do the following:

1. Select a PST bus [crosspoint] .
2. Select the [Bkgd] Transition button. The PST bus scene will appear on the preview monitor (if present).
3. Press the [Cut] Transition button. The PST bus scene will immediately switch on air and the PGM and PST crosspoint selections will flip-flop (swap). Refer to Figure 4-1.

You can also do a hot cut by simply selecting a new PGM bus crosspoint.

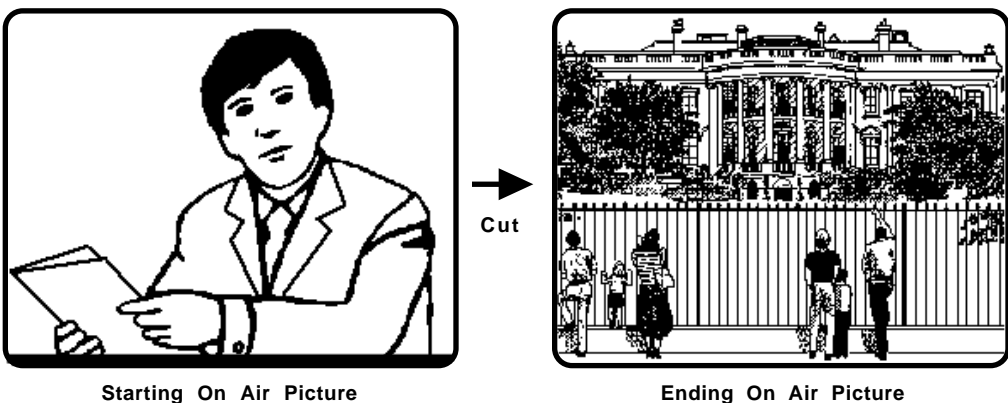

Figure 4-1. Background Cut

Background Mix

A mix (Figure 4-2) is a dissolve from one picture to another. You can mix between Program and Preset bus sources as follows:

1. Select a PST bus [**crosspoint**]
2. Select the [**Bkgd**] Transition button. The PST bus scene will appear on the preview monitor (optional).
3. Select the [**Mix**] Transition button.
4. Move the **lever arm** from one limit to the other. As the lever arm moves, the Preset bus scene will mix on air, the Program scene will mix off, and the Program and Preset crosspoint selections will flip-flop (swap) at the end of the mix.

As an alternative to using the lever arm, press [**Auto Trans**] to do an automatic mix transition. To pause an auto transition in progress, press [**Auto Trans**] again. To resume the transition, press it a third time. You can also start a transition with the lever arm and finish it with an auto transition or vice versa.



Starting Video

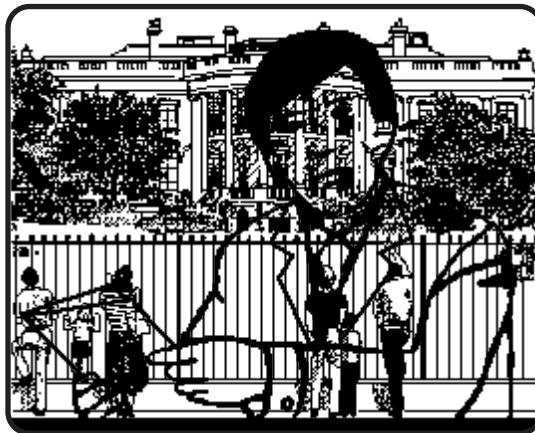

Mix in Progress

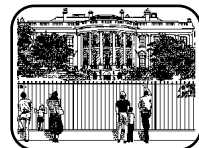

Ending Video

Figure 4-2. Background Mix Transition

Background Wipe

A wipe (Figure 4-3) uses a moving pattern to transition from one picture to another. To wipe between Program and Preset bus sources, do the following:

1. Select a PST bus [**crosspoint**] .
2. Select the [**Bkgd**] Transition button. The Preset scene will appear on the preview monitor (if present).
3. Select the [**Wipe**] Transition button.
4. Select a [**pattern**] button in the Pattern section. If you want to select a menu pattern, press the [**Menu**] button in the Pattern section and select a pattern from the display menu.
5. Select the [**Wipe**] button in the pattern section and adjust pattern modifiers as desired:
 - Wipe Direction – Select the desired direction: [**Normal**] , [**Reverse**] , or [**Flip Flop**] .
 - Edge Width – Select [**Border**] and adjust (**Width**).
 - Edge Softness – Select [**Soft**] and adjust (**Softness**).
 - Edge Color – Select Matte [**Wipe Border**] and adjust the Matte (**Lum**) , (**Sat**) , (**Hue**) , and (**Opacity**) controls.
 - Position – Turn on the [**Pos**] button and move the joystick to move the pattern, if desired. To return the pattern to center, press [**Center**] .
 - Aspect, Rotation, Modulation, Multiplication – Select the Pattern [**Menu**] button or the display [**Wipe**] button to bring up the wipe menus. Adjust menus as desired.

6. To do the transition, move the **lever arm** to the other limit. The Preset bus scene will immediately wipe on air as the Program bus scene wipes off, and the Program and Preset bus crosspoint selections will flip-flop (swap) at the end of the transition.

As an alternative to using the lever arm, you can press **[Auto Trans]** to do an automatic transition. To pause an auto transition in progress, press **[Auto Trans]** again. To resume the transition, press it a third time. You can also start an auto transition and finish with the lever arm or vice versa.

Learning User Wipes

If you develop a wipe setup that you like and you want to save it for future use, you can do so using the User 1-4 buttons:

1. Press **[Learn User Wipe]** , followed by one of the four User buttons, such as **[User 1]** . The current wipe setup will be stored in the User button you selected.
2. To recall a stored user wipe, simply press the appropriate User button. The wipe system will immediately recall the wipe setup previously stored in that User register.

3. If you learn a wipe or do a wipe recall that you don't want, you can undo the learn or recall by pressing **[Undo]** immediately following the learn or recall.



Figure 4-3. Background Wipe Transition

Fade to Black

You can cut or fade the switcher output to black at any time by simply pressing the **[Black Cut]** or **[Black Mix]** button. The fade or cut to black takes place farther downstream in the switcher's architecture than any other effect, so all layers are covered by black. To fade up from black, even if the fade down is still in progress, press **[Black Cut]** or **[Black Mix]** again. When the switcher is fading or faded to black, the Black On lamp lights.

Setting Transition Rates

You can adjust the transition rate for an auto transition, DSK mix, or fade to black using any rate from 1 to 999 frames:

1. In the E-MEM panel area, select **[M/E Trans]** , **[DSK Trans]** , or **[Black Trans]** , depending on which rate you want to set.
2. Use the E-MEM numeric keypad to enter the number of television frames for the transition rate.
3. Press **[Enter]** . The transition rate shown in the rate display near the associated transition controls changes to the new rate.

Matte Effects

Using the Model 1200 Matte controls, you can create a number of interesting mattes to serve as effects backgrounds or fills. To create a simple background matte, follow the procedure below:

1. Select the Transition [**Bkgd**] button, and select a matte or background [**crosspoint**] on the PST bus. The Matte panel controls will automatically delegate to the selected matte.
2. Watch the Preview monitor, and adjust Matte (**Lum**) to set the brightness of the matte. You may want to set a midrange brightness to start and fine tune the brightness later.
3. Adjust (**Hue**) to set the matte color that you want.
4. Adjust Matte (**Sat**) to set the saturation level of the matte.
5. Adjust the Matte (**Opacity**) control to make the matte opaque or transparent.
6. Fine tune all of the above controls as desired. Then use a cut, mix, or wipe transition to place the matte on air.

Luminance and Linear Keying

Luminance and linear keys enable you to insert one picture into another to create a composite effect. For example, you may want to add a caption to a scene (Figure 4-4). For more information about keying, refer to Section 2: Concepts You'll Need To Know.

To create a luminance or linear key, do the following:

1. Double press the Keyer [**Key 1**] , [**Key 2**] , or [**DSK**] button to delegate a keyer and display the Keyer menu.
2. Select a Key bus [**crosspoint**] to provide the fill video. When you select a crosspoint, Key Memory automatically recalls the key type and adjustments last used with that crosspoint.
3. Select [**Auto Select Key**] or [**Video Key**] , as desired. Selecting [**Auto Select Key**] creates the key using both the fill and the source assigned to the crosspoint. Selecting [**Video Key**] produces a self key using only the fill video assigned to the crosspoint.
4. Select [**Luma Key**] or [**Linear Key**] . Note that [**Luma Key**] is usually used for video self keys, and [**Linear Key**] is usually used when keying from anti-aliased graphics, characters, or digital effects images.
5. If you want to split the key (select a source different from the one assigned to the selected fill crosspoint), hold down the [**Video Key**] or [**Auto Select Key**] button and select a Key bus source [**crosspoint**] . The split source crosspoint lights when you select it, and lights anytime you hold down [**Video Key**] or [**Auto Select Key**] . To turn off a split key, hold down the [**Video Key**] or [**Auto Select Key**] button, and reselect the Key bus fill video [**crosspoint**] .
6. For keying from a black on white source, select Keyer [**Invert**] . For keying from a white on black source, leave [**Invert**] off.

7. Set **(Gain)** fully on (CW) and watch the preview monitor as you adjust **(Clip)** to create the key. Then reduce **(Gain)** until the key edge looks good. Also, if you want to adjust the opacity of the key layer, adjust **(Key Opacity)** .
8. To mask parts of the key that you don't want to see, select Keyer **[Mask]** and select a wipe pattern to serve as the mask source. Use the Pattern modifiers (on the panel and in the Wipe menus) to adjust the mask characteristics as desired.
9. To put a border on the key, select a Borderline key edge mode: **[Border]** , **[Shadow]** , **[Extrude]** , or **[Outline]** . To position the edge, hold down the edge mode button and use the joystick. To set the edge color, use the Matte controls. To clear a border mode to its default position and color, hold the edge mode button down and press **[Clear]** . To turn off the border modes, creating an unbordered key, select **[Normal]** edge mode.
10. Transition the key on air as explained on the next page.

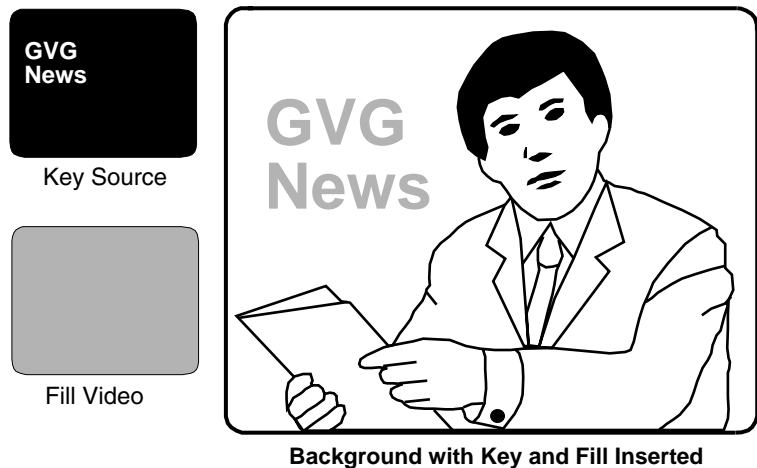

Figure 4-4. Luminance/Linear Key

Key Transition

Effects keys can be cut, mixed, or wiped on air in much the same way as backgrounds. Both the effects keys and a background can be transitioned on or off together or separately. The Downstream Keyer has separate controls and must be transitioned separately.

1. Set up the key.
2. Select Transition **[Key 1]** , **[Key 2]** , and/or **[Bkgd]** to choose which layer(s) the transition will affect.
3. If both effects keys are on air and you want to adjust which layer is on top, select the **[Key Over]** button to toggle the priority. You can also select the **[Prior/Depth]** top menu button and use the Priority/Depth menu to adjust priority or depth. In the menu you can set key priority to any value between 0 and 100%. If you have the Depth option, you can adjust relative depth of the keys and softness where they intersect.

4. Now do the transition:
 - For an effects key cut, press Transition [Cut].
 - For an effects key mix, select [Mix] and move the lever arm from limit to limit or press [Auto Trans].
 - For a wipe, select Transition [Wipe], and select and adjust the pattern as described earlier for background wipes. Then move the lever arm or press [Auto Trans].
 - For a DSK cut, press [DSK Cut].
 - For a DSK mix, press [DSK Mix].
 - When a key is on-air, the Key On indicator lights below the appropriate keyer delegation button on the transition sub-panel (and on the Keyer sub-panel if the on-air keyer is delegated).
5. Once the key is on air, you can change backgrounds behind it: Select [**Bkgd**] only and do a transition.
6. To remove the key(s), select [**Key 1**] and/or [**Key 2**] and do another transition. You can also cut the currently delegated key layer on or off using the Keyer [**Cut**] button.

Preset Pattern Keying

A preset pattern key (Figure 4-5) cuts a key hole in the background in the shape of a wipe pattern. The procedure for creating a preset pattern key is as follows:

1. Select the Keyer [**Key 1**] , [**Key 2**] , or [**DSK**] button to delegate the keyer you want to use.
2. Select a Key bus [**crosspoint**] to provide the fill video. For an over-the-shoulder box, as shown in the figure, the fill video would be a compressed picture from a DPM.
3. Select Keyer [**Preset Pattern**] and [**Video Fill**] .
4. Select a [**pattern**] button in the Pattern section. If you want to select a menu pattern, press the [**Menu**] button in the Pattern section and select a pattern from the display menu.
5. Select the [**Mask/Preset Pattern**] button in the Pattern section and adjust the following pattern modifiers:
 - Size – Adjust the size of the pattern.
 - Edge Width – Select [**Border**] and adjust (**Width**).
 - Edge Softness – Select [**Soft**] and adjust (**Softness**).
 - Edge Color adjust – Select Matte [**Preset Border**] and adjust the Matte [**Lum**] , [**Sat**] , [**Hue**] , and [**Opacity**] controls.
 - Position center – Turn on the [**Pos**] button and move the joystick to move the pattern. Press the [**Center**] button if you want to re-center the pattern.
 - Aspect, Rotation, Modulation, Multiplication – Select the Pattern [**Menu**] button or the [**Wipe**] top menu button to bring up the wipe menus. Adjust as desired.

6. To adjust the opacity of the key layer, adjust **(Key Opacity)** .
7. Transition the key on air as explained previously.

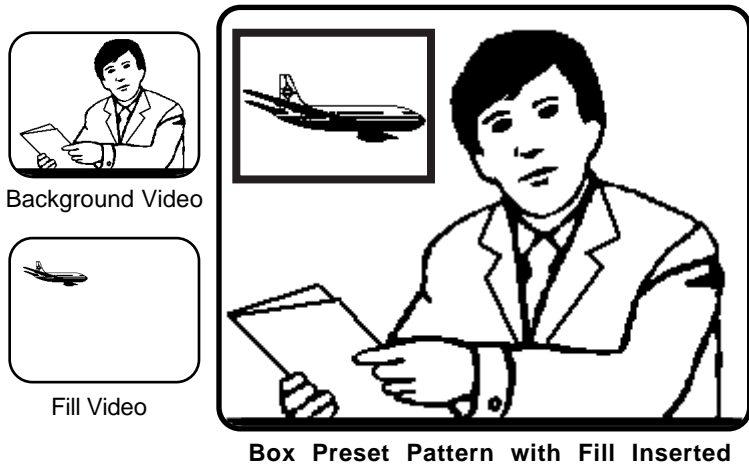

Figure 4-5. Preset Pattern

Chroma Keying

Chroma keying allows you to key out a particular color in a scene and replace it with new background video. A typical application is to position a reporter in front of a blue wall and set up a chroma key to replace the blue wall with a weather map (Figure 4-6).

Given a well-lit and well-composed chroma key scene, the high-quality chroma keyer used in the Model 1200 can produce a clean and natural-looking key with smooth edges and realistic shadows, even when the chroma key scene contains smoke, glass, or liquids.

Creating a chroma key is especially easy with the 1200 Chroma Key Auto Setup feature. This feature automatically sets up the key when you identify the background color. In addition, the Chroma Key Menu gives you several controls for fine tuning the key.

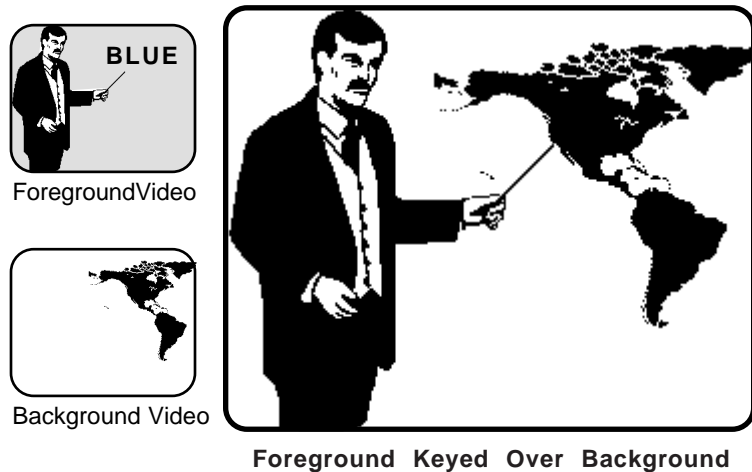

Figure 4-6. Chroma Key

Basic Chroma Keying Procedure

The following steps explain how to use Auto Setup to create an excellent basic chroma key:

1. Select the Keyer [**Key 1**] , [**Key 2**] , or [**DSK**] button to delegate the keyer you want to use.
2. Select a Key bus [**crosspoint**] to provide the chroma key foreground and colored background video.
3. Select a PGM bus [**crosspoint**] to supply the new background video (or select a PST bus [**crosspoint**] if you are previewing the key).
4. Select the Keyer [**Chroma Key**] and [**Auto Setup**] buttons. The joystick will automatically delegate to the Chroma Key Auto Setup feature, and the Chroma Key menu will appear in the visual display. In addition, a crosshair cursor will appear on the Program video monitor.

NOTE: *If the key type buttons all turn off when you press [**Chroma Key**] , the chroma keyer is already in use on another keyer. Only one keyer at a time may use the chroma keyer.*

5. Use the joystick to move the Auto Setup monitor cursor over the color in foreground video that will be keyed out. Then push the “fire” button on the top of the joystick. There will be a momentary delay, and then a finished chroma key will appear on the monitor.

In many cases, no further adjustment of the key is needed. However, if you want to fine tune certain aspects of the key, refer to “Advanced Chroma Keying” in “Section 5 Advanced Operations.”

Using E-MEM Effects Memory

The switcher's E-MEM[®] Effects Memory System includes 20 internal storage registers that you can use to save (learn) switcher panel setups. You can then recall the saved setups at a later time. The memory containing stored setups is protected against power outages, so if power to the switcher is lost, the contents of the E-MEM registers will remain intact.

Learning an Effect

1. Select the **[Learn]** pushbutton so that it lights.
2. Select **[Bank]** and then **[0 or 1]** . This selects one of the two banks of ten E-MEM storage registers. (This step is optional if the bank that you want is already selected.)
3. Select one of the ten **[register]** pushbuttons **[0-9]** . The button will light and the current panel setup will be learned for later recall. After the learn, the **[Learn]** button lamp turns off.

Recalling an Effect

1. Turn off the **[Learn]** button if it is lit.
2. Select **[Bank]** and **[0 or 1]** . (This step is optional if the bank that you want is already selected.)
3. Select the **[register]** pushbutton (**[0-9]**) containing the previously stored panel setup. The panel setup stored in the register will immediately be recalled.

NOTE: *The E-MEM system learns and recalls the switcher controls but does not cue the video and key sources serving as inputs to the switcher. When you recall an effect, you may need to cue your sources to exactly duplicate the picture that existed when the effect was learned.*

Learning Auto Transitions

The E-MEM system can also store an auto transition, DSK mix, or black mix along with a panel setup. When you recall the register, the setup will be recalled and the transitions will occur.

1. Set transition rates for all of the transitions you plan to learn.
2. Select the **[Learn]** pushbutton so that it lights.
3. Select **[Bank]** and **[0 or 1]** . (This step is optional.)
4. Select transitions in any order: **[Auto Trans]** , **[DSK Mix]** , or **[Black Mix]** .

If you decide not to learn a transition, you can cancel it by pressing the transition button again.

5. Select a **[register]** pushbutton. The current panel setup and the selected transitions will be learned.

To recall the effect and transitions, do a recall as described previously.

Undo Function

The **[Undo]** button undoes the most recent E-MEM operation:

To undo an accidental recall, press **[Undo]** immediately after the recall. The panel setup prior to the recall will be restored. You can switch back to the recalled setup again by pressing **[Undo]** a second time. Repeated toggling between the two effects is possible.

To undo a learn, press **[Undo]** immediately after the learn. The previous contents of the affected register will be restored.

5

Advanced Operations

Introduction

This section of the Operation manual presents complex effects you can do with the Model 1200 switcher. As with the previous Basic Operation section, each effect is presented step-by-step, making the effects easy to learn and master.

The following topics are included in this section:

- Proc Amp Controls—page 5-2
- Matte Wash—page 5-4
- Spotlight—page 5-6
- Advanced Chroma Keying—page 5-8
- Using Effects Send to Fly a Key—page 5-10
- Using Aux Buses to Fly a Key—page 5-11

Starting Conditions

To ensure predictable results, before you do any of the following procedures, set the switcher to a known state:

1. Press the [MISC] button located left of the menu display. The Miscellaneous menu will appear in the menu display.
2. Press the [CLEAR WORK BUFFER] soft button below the menu display. This clears the panel to its default state.

Proc Amp Controls

Processing amplifiers are built into the Model 1200. When you double press any video or key crosspoint or press the [PROC AMP] top level menu button, the Proc Amp menu opens, and the following video color correction controls become available:

- Hue
- Chroma Saturation
- Luminance gain
- Luminance offset
- Chroma U offset
- Chroma V offset

These settings are stored in memory for each crosspoint column. So you can set the levels once for a particular crosspoint, and the switcher will always recall those levels when you select that crosspoint or any other crosspoint in that column.

You can adjust the proc amps for a crosspoint as follows:

1. Double press the desired [CROSSPOINT] button to bring up the Proc Amp menu.
2. Adjust the soft knobs in the Proc Amp menu to obtain the desired color correction. If you want to return to the default levels at any time, press the [CLEAR PROC AMP] soft button in the lower left corner of the Proc Amp menu.

The proc amp settings will be remembered and recalled whenever you select that crosspoint or any other crosspoint in the same column.

Monochrome Video Effect

You can use the proc amp controls to create special effects, such as the following monochrome effect:

1. On the PGM bus, double press a video [CROSSPOINT]. This will cause the Proc Amp menu to appear in the menu display.
2. Adjust the (*CHROMA SATURATION*) soft knob in the Proc Amp menu to make the on-air video black and white. If you wish, you can key over this black and white scene with a color image, or you can do a transition to the same background video in full color as follows:
3. Press the [CONFIG] top level menu button, and select the [*XPT MAP*] soft button from the menu that appears. This will bring up the Crosspoint Map menu.
4. In the Crosspoint Map menu, assign the video source selected in step 1 to a second crosspoint. When finished, you should have the same video source assigned to two different crosspoints.
5. Select the newly-mapped [CROSSPOINT] on the PST bus.
6. Now do a background mix or wipe between the monochrome and color versions of the same scene.

Matte Wash

You can produce a matte with graduated shading between two or three colors, called a matte wash. This effect works well as a background for keys and digital effects. As an example, two methods are given below for creating a “sunset” wash:

Matte Wash Method 1

1. Select Transition [BKGD] and [WIPE].
2. Select wipe pattern 0 (second pattern from left in the top row of patterns) and [REVERSE]. All other wipe modifiers should be off for now.
3. Move the lever arm to about mid-travel to advance the wipe about half way up the screen.
4. Select the Bkgd matte [CROSSPOINT] on the PGM bus, and set the Matte controls for a dark blue color at the top of the screen.
5. Select a Matte [CROSSPOINT] on the PST bus, and set the matte controls for a reddish-brown color at the bottom of the screen.
6. Select the Pattern [WIPE] button. Turn on the [BORDER] button, and set the pattern edge (WIDTH) control for a 1-inch wipe border. Use the Matte controls to make the border yellow.
7. Turn on the Pattern [SOFT] button, and adjust pattern edge (SOFTNESS) to soften the entire screen. This completes the wash effect. You can use the downstream keyer to key over the top of the wash.

Matte Wash Method 2

1. Select Transition [BKGD] and [KEY 1].
1. Select Keyer [PRESET PATTERN] and [MATTE FILL].
2. Select the second pattern from the left in the top row of patterns and [REVERSE]. All other wipe modifiers should be off for now.
3. Turn on Pattern [MASK/PRESET PATTERN] and adjust (SIZE) to set the pattern edge to the middle of the preview monitor screen.
4. Select the [BKGD] matte crosspoint on the Key bus, and set the Matte controls for a dark blue color at the top of the preview monitor screen.
5. Select a [MATTE CROSSPOINT] on the PGM and PST buses, and set the matte controls for a reddish-brown color at the bottom of the preview monitor screen.
6. Turn on the pattern [BORDER] button, and set the pattern edge (WIDTH) control for a 1-inch wipe border. Use the Matte controls to make the border yellow. (Pressing [PRESET PATTERN] delegates the Matte controls to the Preset border.)
7. Turn on the Pattern [SOFT] button, and adjust pattern edge (SOFTNESS) to soften the entire screen. This completes the wash effect.
8. Transition the effect on. If you wish, you can key over it with Key 2 and the DSK.

Spotlight

You can create a spotlight effect using a Preset Pattern key as shown in Figure 5-1.

Spotlight Method 1

1. Select Transition [BKGD] and [KEY 1] or [KEY 2].
2. Select a [CROSSPOINT] on the PGM bus. Select the same [CROSSPOINT] on the Key bus. Select [BLACK] on the Preset bus. Watch the Preview monitor to see the effect take shape.
3. On the Keyer panel, select [PRESET PATTERN] and [VIDEO FILL].
4. On the Pattern panel, select the [CIRCLE] pattern. Also select [MASK/PRESET PATTERN] and adjust (SIZE) to set circle size as seen on the Preview monitor. Then turn on [POS] and use the joystick to position the circle.
5. If necessary, select [BORDER], [SOFT], and [SYMM] and adjust pattern edge (WIDTH), (SOFTNESS), and softness (SYMMETRY).

Select Transition [MIX] and move the LEVER ARM partially off the limit to create the spotlight effect.

Spotlight Method 2

1. Select Transition [BKGD] and [KEY 1] or [KEY 2].
2. Select a [CROSSPOINT] on the PGM bus. Select the same [CROSSPOINT] on the PST and Key buses. Watch the Preview monitor to see the effect take shape.
3. On the Keyer panel, select [PRESET PATTERN] and [MATTE FILL].
4. On the Pattern panel, select the [CIRCLE] pattern. Also select [MASK/PRESET PATTERN] and adjust (SIZE) to set circle size as seen on the Preview monitor. Then turn on [POS] and use the joystick to position the circle.
5. Set the Matte controls to make the matte fill black, and then set Matte (OPACITY) to make the matte a transparent shadow.
6. Select Pattern [MASK/PRESET INVERT]. This will place the transparent shadow matte outside the pattern over the background video, highlighting the video inside the circle.
7. Fine-tune as desired. Then cut or mix the spotlight on air.

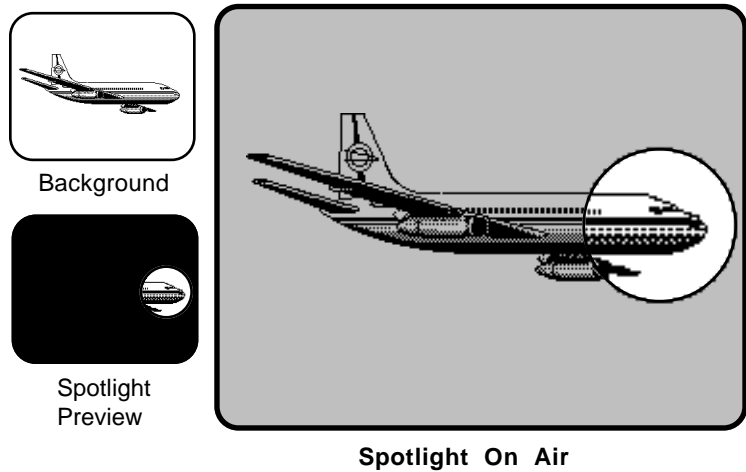

Figure 5-1. Spotlight Effect

Advanced Chroma Keying

Chroma Key Auto Setup typically produces an excellent chroma key that does not require further adjustment, but in some cases careful adjustment yields an even better key. The following procedure explains how to adjust the Chroma Key menu controls for an optimum chroma key.

1. Start by setting up a basic chroma key using Chroma Key Auto Setup. The procedure for doing this is presented in “Section 4 Basic Operations.”
2. Make fine adjustments first to the (CLIP) control and then to the (GAIN) control. (CLIP) adjusts foreground transparency, and (GAIN) adjusts the background shadow noise level. In some cases increasing (BKGD LUMA SUPPRESS LEVEL) in the Chroma Key menu helps reduce noise.
3. Examine the foreground for color splash of the background onto the foreground. If this exists, move to the Chroma Key Fgd Suppress menu. In that menu, turn [FGD COLOR SUPPRESS] ON, and then adjust the (FOREGROUND HUE SELECT ANGLE) to achieve the greatest level of foreground color correction. Adjusting (SELECTIVITY) may help if set to about 15%. Some iterative adjustment of these two controls may be necessary to achieve best results.
4. Use the [SUPPRESS LEVEL] soft button to select LUMA. Then adjust (FOREGROUND LUMA SUPPRESS LEVEL) for the most natural representation of light through or reflected from the new background.
5. If some areas where you corrected color distortion appear gray, adjust the (FRINGE CONTROL) soft knob to restore color to these gray areas. Too much fringe adjustment will begin to shift the color of the entire foreground.

6. If the foreground scene appears too neutral, you can shift its hue by pressing the *[HUE ANGLE]* soft button to choose *SUPPRESS*, and then adjusting the *(FOREGROUND HUE SUPPRESS ANGLE)* soft knob. This control is useful for correcting colors that have become distorted by mixing with the background color. This adjustment works especially well on transparent portions of the foreground, such as a glass of red wine that became magenta as a result of mixing with the background color.
7. Now examine the foreground edges for dark or light lines, indicating that the background key hole size or position does not match the foreground fill. If the edges exhibit this problem, press *[EXIT]* to move to the Chroma Key main menu, and then select *[KEY EDGE]* to move to the Key Edge menu. Select *ON* above the *[V EDGE PROC]* soft button, then select and adjust the *(KEY SIZE)*, *(KEY SOFTNESS)*, and *(KEY POSITION)* soft knobs to minimize the lines along the edges of the key.
8. Use the *[EDGE CONTROL]* soft button to switch between a multiplicative key and an additive key. Use whichever looks best. A multiplicative key works best for smoke because it softens the appearance of the key. An additive key works better when you prefer to see greater detail in the key.
9. If there is still some noise in the background, try switching *[V EDGE PROC]* to the *[TEMPORAL]* position to enable temporal filtering. This may remove a small amount of noise, but it may also cause motion artifacts, so you may want to roll the tape and watch for them.
10. To add shadows to the new background, adjust the Keyer (*GAIN*) knob. Then press *[EXIT]* to return to the main Chroma Keyer menu, and select *[SHADOW PROC>]*. In this menu, turn *[SHADOW PROC] ON*. Set *(SHADOW GAIN)* and *(SHADOW OPACITY)* to 100%, and adjust *(SHADOW CLIP)* until nearly all of the background is black. Then reduce *(SHADOW GAIN)* until the shadow density looks best. Lastly, touch up the Keyer (*GAIN*) knob to reduce shadow noise while preserving the key edge.

This completes the advanced chroma key adjustments.

Using Effects Send to Fly a Key

Effects Send makes it easy to use an external DPM to fly any type of switcher key over a switcher background (Figure 5-2). To use Effects Send, do the following:

NOTE: Before you can use Effects Send, the Effects Send Output option must be installed in the switcher, the switcher and DPM must be properly interconnected, and the Effects Send Return crosspoints must be assigned using the Configuration/Define Inputs menu.

1. Set up the key using one of the switcher's effects keysers.
2. Select that keyer in the Effects Send area of the 1200 panel.
3. Use the DPM to manipulate the key and fill.
4. Use the Transition controls to transition the flying key on air over a switcher background. You can also use the other keyers in the switcher to add more key layers.

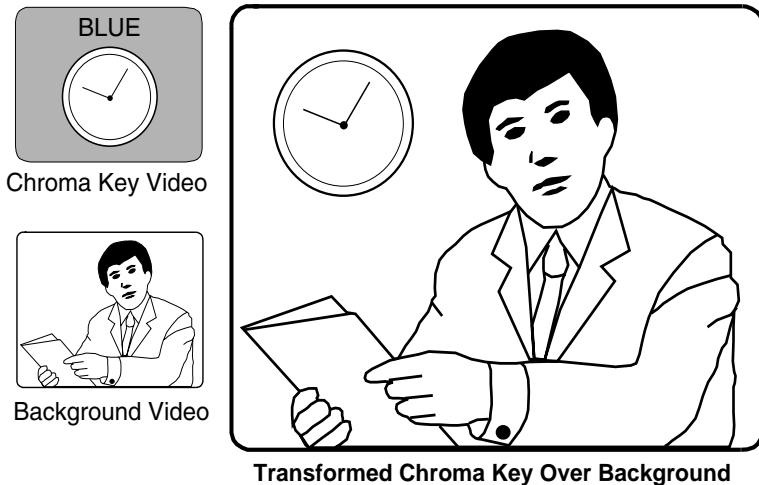

Figure 5-2. Flying a Chroma Key Using Effects Send

Using Aux Buses to Fly a Key

Another way to fly a key in the switcher is to use the Aux Buses to select inputs for a DPM. The DPM outputs can then be applied to switcher inputs which can be used for keying.

To fly a key using this method, do the following:

NOTE: *The switcher's Aux Bus outputs must be connected to the DPM's inputs, and the DPM's outputs must be connected to the switcher's inputs and assigned to crosspoints in the Configuration/Crosspoint Mapping menu. In addition, the Configuration/Define Inputs menu must be set up to map the DPM key as the Auto Select Key Source for the DPM video input.*

1. In the Bus Delegates section of the panel, delegate the Aux Bus that feeds the DPM key channel. Then select the Aux bus [CROSSPOINT] corresponding to the key source you intend to use.
2. Delegate the Aux bus that feeds the DPM video channel. Then select the Aux bus [CROSSPOINT] corresponding to the fill video you intend to use.
3. Use the DPM to manipulate the key and fill simultaneously.
4. Set up a key on the switcher, selecting the DPM input [CROSSPOINT] on the Key Bus to provide the key fill and source.
5. Use the switcher Transition controls to transition the key on air over a switcher background.



Index

A

Alternate Xpt Map **2-26, 3-72**
AUTO SELECT **4-9**
Auto Select Key **3-7, 3-18**
Auto Setup **3-20, 4-15, 4-16**
AUTO TRANS **4-3, 4-5**
Auto Trans **3-35**
Auto Transition Rate **3-4**
Aux 1 **3-4, 3-11**
Aux 2 **3-4, 3-11**
Aux Bus 1 **3-8**
Aux Bus 2 **3-8**
Aux Bus Tally Back **2-26, 3-72**
Aux Buses **5-11**
auxiliary bus **2-3**

B

Background **2-6, 4-2**
background buses **2-3**
BKGD **3-5, 3-33, 4-3, 4-4**
Black Cut **3-16**
Black Mix **3-16**
Black Trans **3-14**
Border **3-24**
Borderline **3-4**
Bus Delegates **3-11**

C

Chroma **3-26**
Chroma Key **3-19, 3-20**
Chroma Key Auto Setup **4-15**
chroma key source and fill **4-16**
Chroma Key Sources **2-18**
Chroma Keying **4-15, 5-8, 5-10**
Clear **3-14**
Clip **2-6, 3-23, 4-10**
Configuration Menu **2-13**
Crosspoint Buses **3-4, 3-5**
Crosspoint Display Legends Menu **2-19**
Cut **2-4, 3-35, 4-2**

D

Depth **2-11**
Downstream Keyer **3-9, 4-11**
DPM **5-10, 5-11**
DSK **3-7, 3-9, 3-11, 3-17**
DSK CUT **3-9, 4-12**
DSK Cut **3-10**
DSK lamp **3-9**
DSK MIX **3-9, 3-10, 3-13, 4-12**
DSK On lamp **3-9**
DSK PVW **3-9, 3-10, 4-9, 4-13**
DSK Trans **3-14**
DSK Transition Rate display **3-10**

E

Editor Enable **3-15**
Effects keys **4-11**
Effects Send **3-8, 3-11, 5-10**
Effects Send Output option **5-10**
E-MEM auto transitions **4-18**
E-MEM Effects Memory **3-12, 4-17**
Enter **3-14**
External Interface **3-15**
Extrud **3-24**

F

Fade To Black **3-12, 3-13, 3-16, 4-6**
Features of the Model 1000 **1-2**
Field Dominance **2-14**
fill **2-6**
fill video **4-9**
flip-flop **3-6**
Fly a Key **5-10, 5-11**

G

GAIN **2-6, 3-23, 4-10**
GPI **2-26**
GPI Enable **3-15**

H

High Clip **3-23**
Hue **3-26**

I

Inputs **2-16**

J

joystick **5-6, 5-7**

K

Key 1 **3-7, 3-11, 3-17, 3-33, 4-9, 4-13**
Key 2 **3-7, 3-11, 3-17, 3-33, 4-9, 4-13**
Key Bus **3-7, 4-9, 4-13**
key buses **2-3**
Key Copy **3-25**
KEY INVERT **4-9**
KEY MASK **4-10**
Key Memory **3-7, 3-25**
Key Modifiers and Adjustments **3-21**
Key Opacity **3-22**
key source **2-6, 4-9**
Key Source Type **3-18**
Key Transitions **4-11**
Key Type **3-19**
Keyer **3-17**

L

LampSave **2-2**
LEARN **4-17**
Learn Button **3-12**
Learn User Wipe **3-29**
Learning an Effect **4-17**
Learning Auto Transitions **4-18**
Lever arm **3-35, 4-3, 4-5, 4-12, 5-6**
LINEAR KEY **3-19, 4-9**
Linear Key **3-19**
Low Clip **3-23**
Lum **3-26**
LUM KEY **3-20, 4-9**
Luma Key **3-19, 3-20**
Luminance and Linear Keying **4-9**

M

M/E Trans **3-14**
Mask/Preset Pattern **3-30**
Matte **3-5, 3-26**
Matte Effects **4-8**
Menu button **3-29**
MIX **3-34, 4-3, 5-6**
Mix **3-34**
Model 1000 architecture **1-4**
Model 1000 Overview **1-4**
Monochrome Video **5-2**

N

Normal **3-24**

O

OPACITY **3-26, 4-10, 4-14, 5-7**
Outline **3-25**
Outputs **2-22**

P

Pattern Control **3-28**
Pattern Modifiers **3-30, 4-4, 4-13**
Pattern Selection Buttons **3-29**
Ports **2-24**
POSITIONER **5-6, 5-7**
Positioner (Joystick) **3-30**
Preset Background Bus **3-6**
Preset bus **2-4**
Preset Pattern **3-19, 3-21**
Preset Pattern Effects **4-11**
PRESET PTN **4-13, 5-6, 5-7**
processing amplifier **3-5**
Program Background Bus **3-6**
Program bus **2-4**

R

Register Buttons **3-13**
register pushbuttons **4-17**
Reverse **3-30**

S

Satellite Aux Bus Panels **3-8**
Setup, Using the Terminal for **2-12**
sleep mode **2-2**
SOFTNESS **4-4, 4-13, 5-6**
Softness **3-31**
Split Key **3-7, 3-18**
Spotlight **5-2**
S-shaping **2-6**
Starting Conditions **4-1, 5-1**
sunset wash **5-4**
suppression **2-8**
System Parameters **2-14**
System Startup or Restart **2-3**

T

tally **3-16**
Timing **2-23**
Trans Buttons **3-14**
Transitions **4-2, 4-11, 5-2**

U

Uncal lamp **3-5**
Undo **3-13**
User 1 **3-29**
User Wipe **3-29**

V

Video Key **3-7, 3-18**

W

WIDTH **4-4, 4-13, 5-6**

WIPE **3-30, 3-34, 4-4, 4-12**