

Instruction Manual

software release **1.0**

071806600

FIRST PRINTING: **JANUARY 2001**

2042EDA
DUAL WIDEBAND EQUALIZING DA

Contacting Grass Valley Group

Region	Voice	Fax	Address	Web Site
North America	(800) 547-8949 530-478-4148	(530) 478-3347	Grass Valley Group P.O. Box 599000	www.grassvalleygroup.com
Pacific Operations	+852-2585-6688 Support: 852-2585-6579	+852-2802-2996	Nevada City, CA 95959-7900 USA	
U.K., Europe, Asia, Middle East	+44 1753 218 777	+44 1753 218 757		
France	+33 1 45 29 73 00			
Germany	+49 221 1791 234	+49 221 1791 235		

Copyright © Grass Valley Group. All rights reserved.

This document may not be copied, in whole or in part, or otherwise reproduced, except as specifically permitted under U.S. copyright law, without the prior written consent of Grass Valley Group, P.O. Box 599000, Nevada City, CA 95959-7900 USA. GRASS VALLEY GROUP is a registered trademark and Grass Valley is a trademark of Grass Valley Group. All registered trademarks and trademarks are property of their respective holders. Grass Valley Group products are covered by U.S. and foreign patents, issued and pending. Product options and specifications subject to change without notice. The information in this manual is furnished for informational use only, is subject to change without notice, and should not be construed as a commitment by Grass Valley Group. Grass Valley Group assumes no responsibility or liability for any errors or inaccuracies that may appear in this publication.

Contents

Preface

About This Manual v

2042EDA Dual Wideband Equalizing Distribution Amplifier

Introduction 1
Installation 2
 Module Placement in the 2000 Frame. 2
 Cabling 5
 Inputs 5
 Outputs 5
Power Up 6
 Operation Indicator LEDs 6
Configuration and Monitoring 8
 Remote Monitoring 8
 Module Configuration Displays 9
 Software Update Displays 9
Specifications 10
Service 12
 Power-up Diagnostics Failure 12
 Troubleshooting 12
 Module Repair 12
Functional Description 13
 Input Processing 13
 Microprocessor 13
 Output Processing 14
 Power Supply 14

Index

Preface

About This Manual

This manual describes the features of a specific module of the 2000 Series Modular Products family. As part of this module family, it is subject to Safety and Regulatory Compliance described in the 2000 Series frame and power supply documentation (see the *2000 Frames Instruction Manual*).

2042EDA Dual Wideband Equalizing Distribution Amplifier

Introduction

The 2042EDA Dual Wideband Equalizing DA provides two wideband channels for equalization and distribution of standard or high definition input signals (4 Mb/s to 1.5 Gb/s) to four outputs each. The module set includes a media module that resides in the front of a 2000 Series frame and a passive rear module for input and output connections.

The features of the 2042EDA include:

- Auto equalization of standard and high definition signals,
- Accepts a wide range of standard or high definition input signal standards,
- Use of non-inverted outputs allow distribution of compressed signals such as SMPTE 310M and DVB-ASI, and
- Remote monitoring support.

Installation

Installation of the 2042EDA module set is a process of:

- Placing the passive rear module in a frame slot,
- Placing the media module in the corresponding front slot, and
- Cabling and terminating signal ports.

The 2042EDA module can be plugged in and removed from a 2000 Series frame with power on. When power is applied to the module, LED indicators reflect the initialization process (see [Power Up](#) on page 6).

Module Placement in the 2000 Frame

There are twelve slot locations in both the front and rear of a 3RU frame to accommodate 2000 Series modules. The 2042EDA consists of a two module set with a front media module and a passive rear module that can be plugged into any of the 12 frame slots. Each 2042EDA front media module plugs into the front of the 2000 frame mid-plane. The passive rear module plugs into the corresponding rear slot to provide the input and output interface connectors.

To install a 2042EDA module set in the frame:

1. Locate a vacant slot in the rear of the 3 RU frame ([Figure 1](#)).

Figure 1. 3 RU Frame, Rear View

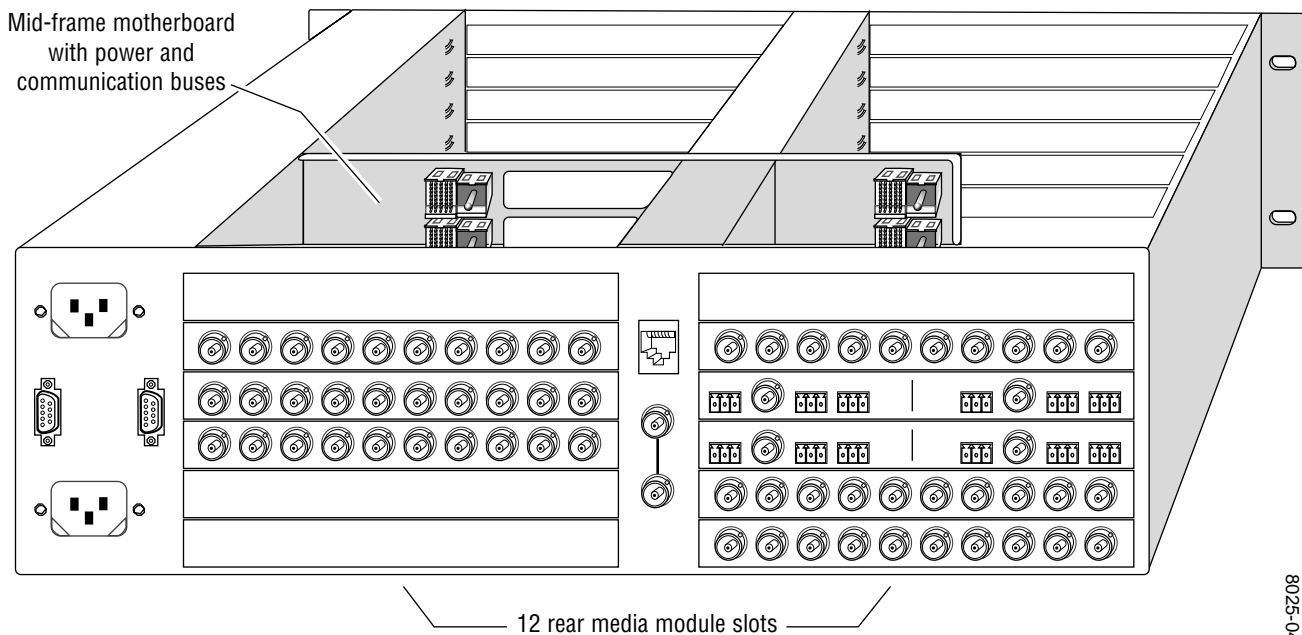

2. Insert the passive rear module into any vacant rear slot (1 – 12) of the frame as illustrated in [Figure 2](#).

Figure 2. Installing Passive Rear Module

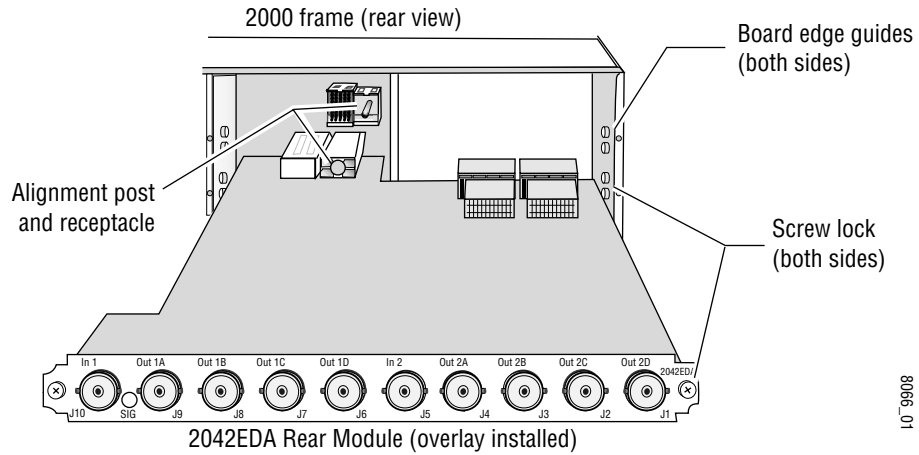

3. Verify that the module connector seats properly against the midplane.
4. Using a crossblade screwdriver, tighten the two screw locks to secure the module in the frame.
5. Install the overlay provided at the rear of this manual (hard copy only) for input and output locations.

6. Locate the corresponding front slot in the frame. The 3 RU frame front view is illustrated in [Figure 3](#).

Figure 3. 2000 Series 3 RU Frame, Front Slots

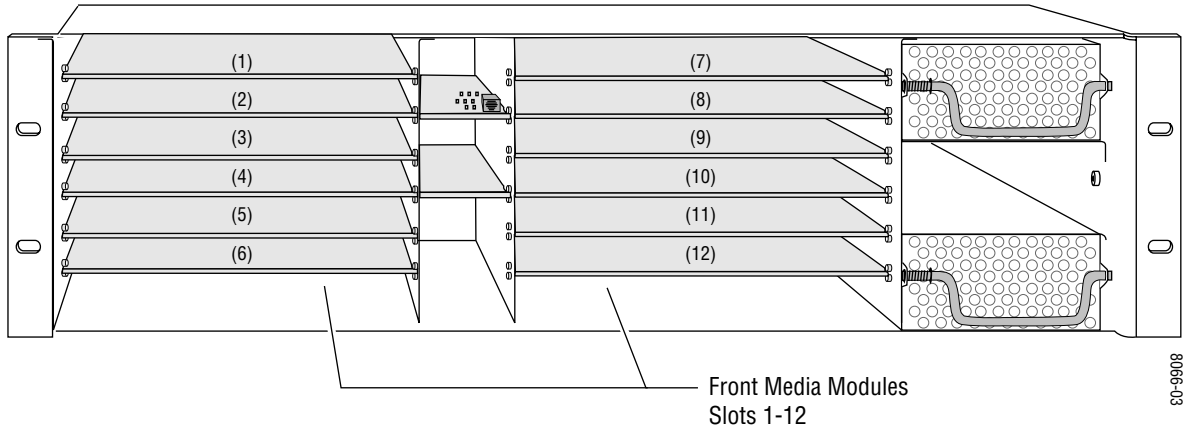

7. With the component side up, insert the front media module in the corresponding front slot (see [Figure 4](#)).
8. Verify that the module connector seats properly against the midplane and rear module connector.
9. Press firmly on both ejector tabs to seat the module.

Figure 4. Installing Front Media Module

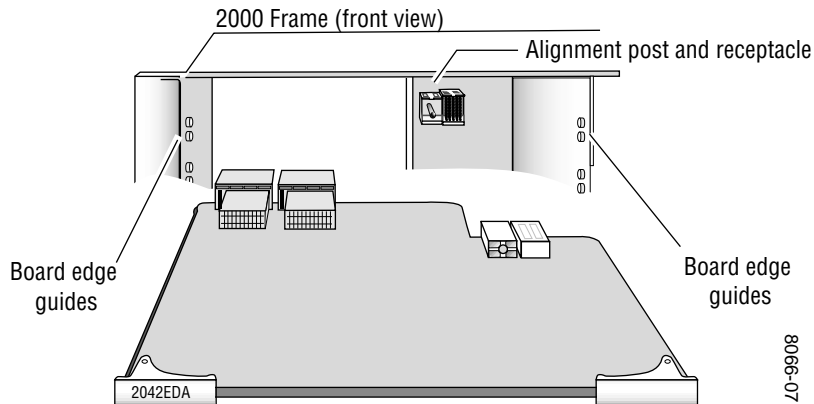

Cabling

Cabling to the 2042EDA module is done on the BNCs on the passive rear module. Refer to [Figure 5](#) for a detailed illustration of the rear connections referenced below.

Inputs

The 2042EDA will accept any of the video standards listed in the Input specifications in [Table 3 on page 10](#). Connect a video input to In 1, BNC J10 and In 2, BNC J5.

Outputs

The 2042EDA outputs conform to the video standards listed in the Output specifications in [Table 3 on page 10](#).

Connect video destinations to the four outputs for In 1 at Out 1A – Out 1D (BNCs J9 – J6 respectively) and the four outputs for In 2 at Out 2A– Out 2D (BNCs J4 – J1 respectively). Terminate any unused outputs.

Figure 5. 2042EDA Input/Output Connectors (with overlay installed)

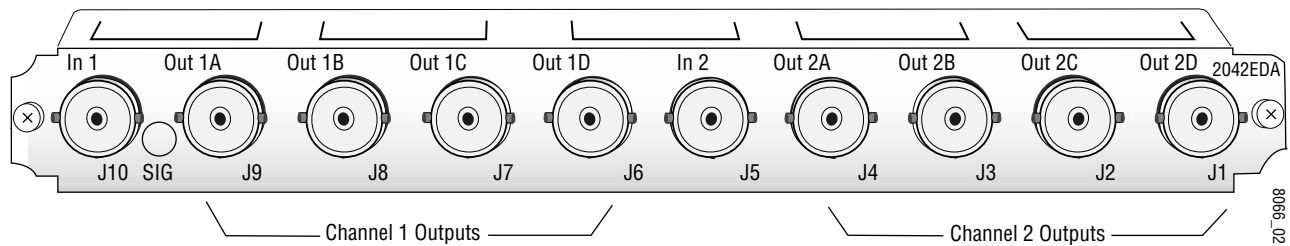

Power Up

The on-board LED indicators are illustrated in [Figure 6](#). Upon power-up, the green PWR LED should light and the yellow CONF LED should illuminate for the duration of module initialization.

Operation Indicator LEDs

With valid input signals connected to In 1 and In 2, the green on-board PWR LED, SIG 1 PRES LED, SIG PRES 2 LED and the SIG LED (visible from the rear of the passive rear module) should be on. The FAULT LED should be off.

Refer to [Table 1 on page 7](#) to see a complete list of possible operating conditions and the resulting indicator status.

Figure 6. 2042EDA Indicator LEDs

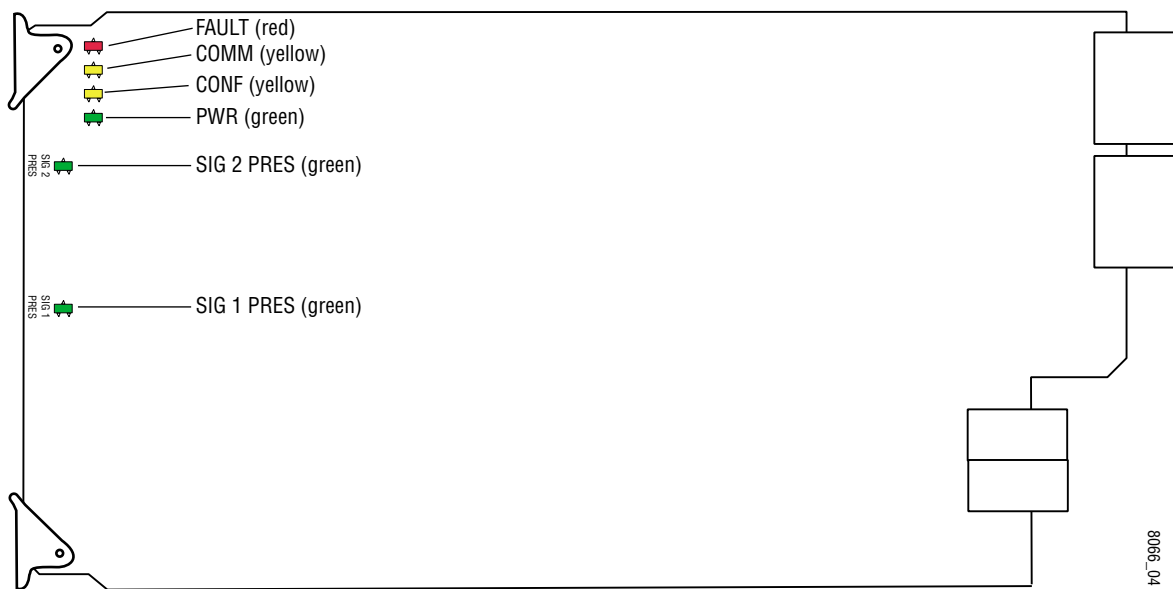

A red FAULT LED indicates an error situation and, when noted with the other indicator LEDs, can indicate a specific problem area. Table 1 describes signal output and LED indications for the various input/reference combinations.

Table 1. Indicator LEDs and Conditions Indicated

LED	Indication	Condition
FAULT (red)	Off	Normal operation
	On continuously	Module has detected internal fault
	Long flash	No input signal on input 1 or input 2
COMM (yellow)	Off	No activity on frame communication bus
	Long flash	Location Command received by the module from a remote control system
	Short flash	Activity present on the frame communication bus
CONF (yellow)	Off	Module is in normal operating mode
	On continuously	Module is initializing, changing operating modes or updating firmware
PWR (green)	Off	No power to module or module's DC/DC converter failed
	On continuously	Normal operation, module is powered
SIG 1 PRES (green)	Off	Indicates input 1 signal carrier missing or over EQ range
	On	Indicates input 1 signal carrier present
SIG 2 PRES (green)	Off	Indicates input 2 signal carrier missing or over EQ range
	On	Indicates input 2 signal carrier present
SIG (rear view) (green)	Off	Indicates both input 1 and 2 signal carriers missing
	On continuously	Indicates both input 1 and 2 signal carriers present
	Long Flash	Indicates input 1 missing, input 2 present
	Short Flash	Indicates input 1 present, input 2 missing

Table 2 provides the possible input and output conditions that result from different input signals and conditions.

Table 2. Input and Output Conditions

Input Condition	Output Condition
Serial Digital Component (SDI)	Serial Digital Component (SDI)
HD Digital Component (SDI)	HD Digital Component (SDI)
Other carrier (SMPTE 310M, DVB-ASI)	Other carrier (SMPTE 310M, DVB-ASI)
No input signal	Muted
Cable exceeding 200 – 300 meters	Muted

Configuration and Monitoring

The 2042EDA has no configuration requirements. There are no local jumpers or controls on the 2042EDA module.

Remote Monitoring

2042EDA monitoring can be performed remotely using the 2000NET interface (see Figure 7). This section describes the GUI access to the module monitoring functions. Refer to the 2000NET Network Interface Module Instruction Manual for information on setting up and operating the 2000 frame network.

Note The physical appearance of the menu displays shown in this manual represent the use of a particular platform, browser and version of 2000NET module software. They are provided for reference only. Displays will differ depending on the type of platform and browser you are using and the version of the 2000NET software installed in your system.

The 2000 modules can be addressed by clicking on a specific module icon in the frame status display or on a module name or slot number in the link list on the left.

Figure 7. 2000NET GUI

The Links section lists the frame and its current modules. The selected link's Status page is first displayed and the sub-list of links for the selection is opened. The sub-list allows you to select a particular information page for the selected device.

Content display section displays the information page for the selected frame or module (frame slot icons are also active links).

8026_08

The screenshot displays the 2000NET GUI interface. On the left, a 'Frame' menu is visible with options for 'Status' and 'Configuration'. Below this is a list of links for various slots: 1 Media Slot 1, 2 Media Slot 1, 3 Media Slot 1, 4 Media Slot 1, 5 Media Slot 1, 6 Media Slot 1, 7 Media Slot 1, 8 Media Slot 1, 9 Media Slot 1, 10 Media Slot 1, 11 Media Slot 1, 12 Media Slot 1, 13 2000NET, 15 Media Slot 1, 19 Power Sled Slot 1, and 21 Power Sled Slot 3. The main content area is titled 'Frame Status' and shows details for a '2000T3N' module located in 'Studio B'. It reports a 'Temperature State : PASS' and 'Fan Status Summary : PASS'. Below this is a 'Front View' grid showing the physical layout of the module's slots. The grid consists of 8 rows and 4 columns. The top row contains 'Media Module', 'Net Card', 'Empty', and 'Empty'. The second row contains 'Empty', 'Media Module', and 'Empty'. The third row contains 'Media Module', 'Empty', 'Empty', and 'Empty'. The fourth row contains 'Media Module', 'Empty', 'Empty', and 'Empty'. The fifth row contains 'Media Module', 'Media Module', and 'Power Sled'. The sixth row contains 'Media Module', 'Empty', and 'Empty'. The 'Net Card' and 'Power Sled' slots are highlighted in green. Below the grid is a 'Properties' section showing 'Vendor : Grass Valley Group', 'Net Card Software Version : 2.0.0', and 'Media Slots : 24'.

Module Configuration Displays

The 2000 GUI provides the following links and displays for the 2042EDA module (Figure 8):

- Module Configuration displays showing front and rear module status and slot configuration information (location and user assigned names), and
- Software Update display.

The Module Configuration displays operate in the same manner for all remote controllable 2000 modules. Refer to the 2000NET manual for more information on these displays. Some functions listed may not be supported by a particular module. These will be indicated as not supported.

Figure 8. 2042EDA Display Links

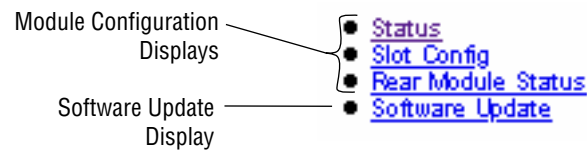

A Rear Module Status display (Figure 9) is provided to check the presence of the correct passive rear module for the 2042EDA front media module. One of the following messages will be reported in the Rear Module Present display:

- Correct Module,
- Incorrect Module, or
- Module Missing.

Figure 9. Rear Module Status Display

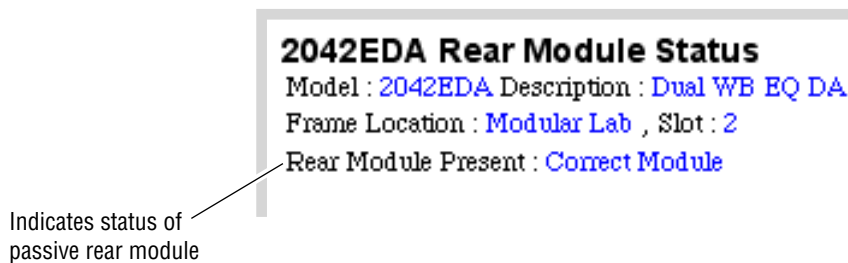

Software Update Displays

The Software Update display allows you to download new software versions for the module. Refer to the 2000NET manual and the Grass Valley Group web site at <http://www.grassvalleygroup.com> for complete details and new software versions.

Specifications

Table 3. 2042EDA Specifications

Parameter	Value
Serial Digital Component Inputs (Channel 1 and Channel 2)	
Number and type of inputs	1 BNC per channel
Input impedance	75 Ω
Input signal type	Serial digital component conforming to the following formats: <ul style="list-style-type: none"> • SMPTE 292M • SMPTE 259M (143 Mbps, 177 Mbps, 270 Mbps, 360 Mbps) • EBU 1697 • 4 Mbps to 1.5 Gbps with PN20 pseudonoise sequence, maximum ratio of 19/1 • SMPTE 310M • DVB-ASI
Signal level	SDI 800 mV \pm 10% max
Return loss	>15 dB to 0.004 to 1.5 GHz
Equalization	Auto equalizing: HD signals: up to 90 m of Belden 8281 cable or 120 m of Belden 1694, SD signals and other <540 Mbps signals: up to 100 m of Belden 8281 or equivalent
Serial Digital Component Outputs (Channel 1 and Channel 2)	
Number and type of outputs	4 BNCs per channel
Output impedance	75 Ω
Signal type	Serial digital component conforming to the following formats: <ul style="list-style-type: none"> • SMPTE 292M • SMPTE 259M (143 Mbps, 177 Mbps, 270 Mbps, 360 Mbps) • EBU 1697 • 4 Mbps to 1.5 Gbps with PN20 pseudonoise sequence, maximum ratio of 19/1 • SMPTE 310M • DVB-ASI
Signal level	SDI 800 mV \pm 10% max
Return loss	>15 dB to 0.004 to 1.5 GHz
Error checking	Transparent to embedded EDH
Electrical length	22 ns \pm 1 ns
Rise and fall time	160 – 270 ps between 20 – 80%
Output polarity	Non-inverted
Jitter	< 0.2 UI
Modes of Operation	
Operating modes	Equalizing in wideband mode
Reclocking modes	None
Non-reclocking modes	4 Mbps to 1.5 Gbps with maximum P/N ratio of 19/1
Auto mute	Output muted for long cable lengths (mute point varies between 200 – 300 m.)
Power	

Table 3. 2042EDA Specifications

Parameter	Value
Input power maximum	<7 Watts
Environmental	
Frame temperature range	0 to 45 ° C
Non-operating temperature	-10 to +70 ° C
Operating humidity range	10% to 90% non-condensing

Service

The 2042EDA modules make extensive use of surface-mount technology and programmed parts to achieve compact size and adherence to demanding technical specifications. Circuit modules should not be serviced in the field unless otherwise directed by Customer Service.

Power-up Diagnostics Failure

If the module has not passed self-diagnostics, do not attempt to troubleshoot. Return the unit to Grass Valley (see [Module Repair](#)).

Troubleshooting

If your module is not operating correctly, proceed as follows:

- Check frame and module power. If power is not present, check the fuse on the +24V input to the module as illustrated in [Figure 10](#).
- Check for presence and quality of input signals.
- Verify that source equipment is operating correctly.
- Check cable connections.

Figure 10. Location of Module Fuse

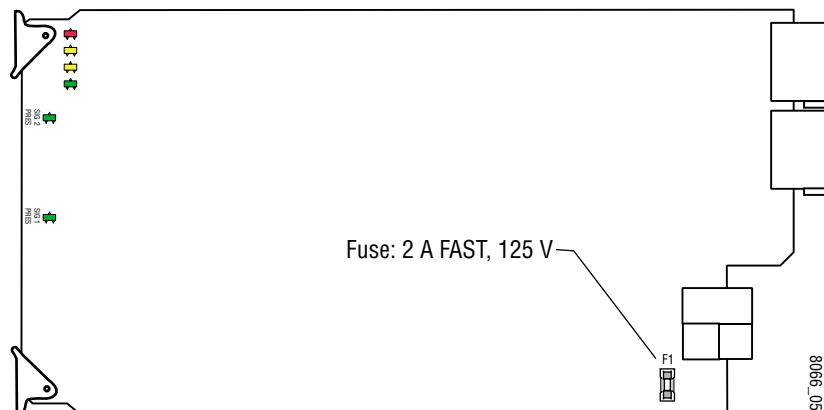

Module Repair

If the module is still not operating correctly, replace it with a known good spare and return the faulty module to a designated Grass Valley repair depot. Call your Grass Valley representative for depot location.

Refer to [Contacting Grass Valley Group](#) at the front of this document for the Grass Valley Customer Service Information number.

Functional Description

A block diagram of the 2042EDA is shown in [Figure 11](#).

Figure 11. 2042EDA Block Diagram

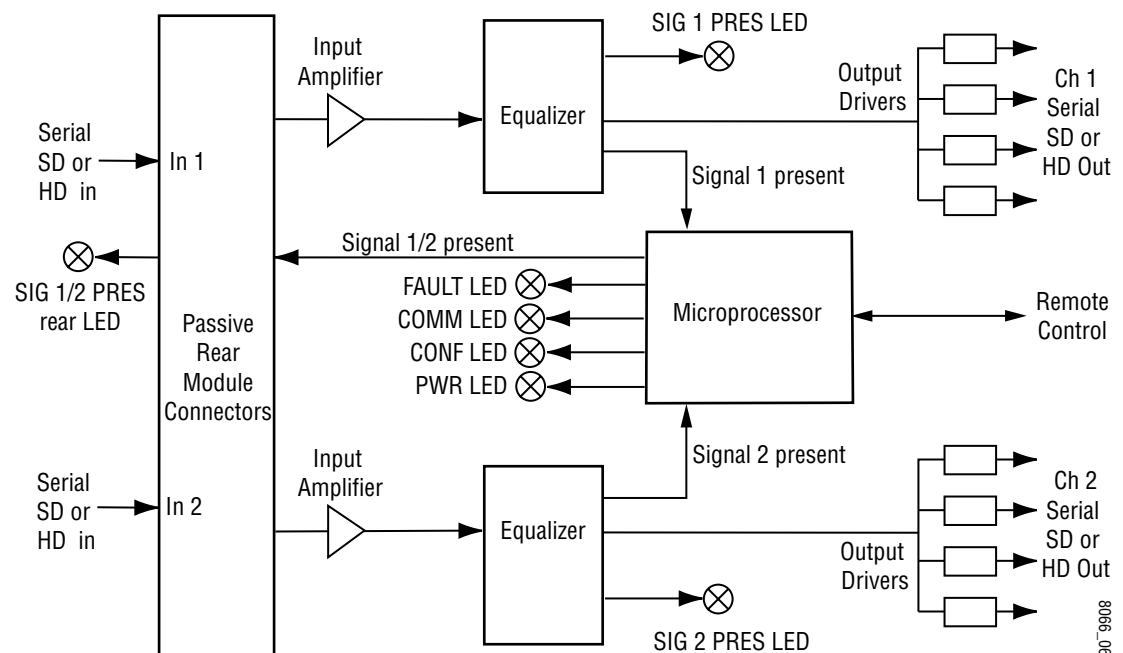

Input Processing

The two wideband channels for serial SD or HD signals enter the module from rear BNCs J10 (In 1) and J5 (In 2) on the passive rear module to input amplifiers. The signals are then equalized for specified cable lengths in the equalizer circuit.

Microprocessor

The main functions of the microprocessor include:

- Providing remote control and monitoring capability for the module (through ethernet),
- Communicating with equalizer ICs to monitor signal present status, and
- Relaying module status through on-board LEDs.

Output Processing

Driver circuits feed each of the four serial digital outputs for each input to the rear BNCs J6 – J9 (Out 1A – Out 1D) and J1 – J4 (Out 2A – Out 2D) on the passive rear module. These outputs are non-inverting and are in-phase with each other.

Power Supply

Power is fed from +24 V rails of the frame's switching power supply. The power input is protected by a socketed fuse (Figure 10). Each amplifier circuit on the module receives its own, separate, highly regulated and filtered power source to reduce EMI and on-board crosstalk.

Index

Numerics

2000NET module 9

B

block diagram 13

C

cabling

inputs 5

outputs 5

circuit descriptions 13

COMM LED 7

CONF (configuring) LED 6,7

configuration 8

E

environmental 11

equalization 1

F

FAULT LED 6,7

fault table 7

frame status display 8

frame, 3RU 2

fuse 12,14

G

GUI 8,9

I

inputs 5

specifications 10

installation 2

L

LEDs 6

M

media module 2

installation 4

midplane 4

monitoring

remote 8

N

network 8

O

outputs 5

overlay 3,5

P

passive rear module 2

installation 2

PWR LED 6,7

R

Rear Module Status display 9

repair depot 12

S

SIG 1 PRES LED 6,7

SIG 2 PRES LED 6,7

SIG LED (rear) 6,7

software update 9

specifications 10

T

troubleshooting [12](#)

2042EDA Dual Wideband DA PRM Rear Connector Overlays

Fold along vertical lines to break perforations, then tear to separate vertical strips.

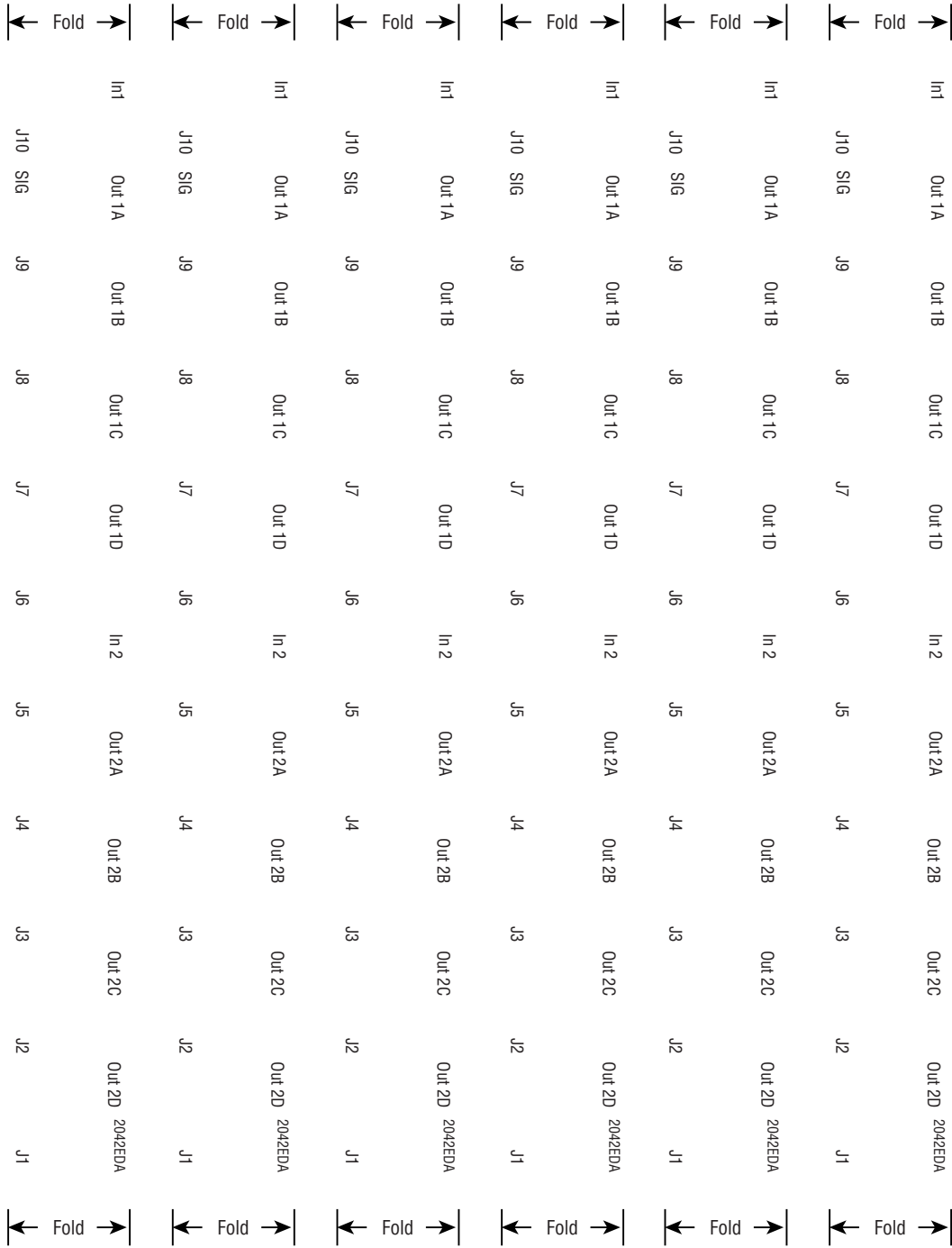

2042EDA Dual Wideband DA PRM Rear Connector Overlays

Fold along vertical lines to break perforations, then tear to separate vertical strips.

